

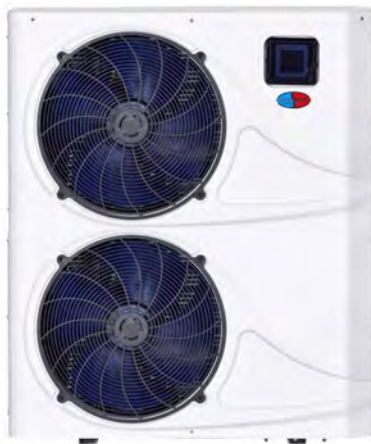

FORCE 26 3-PHASE MANUAL



Installation & Operation

Read this manual carefully before
installing or operating this unit

CONTENTS

1. Preface	1
2. Specifications	2
.....
.....
3. Installation and Connection	5
3.1 Installation of System	5
3.2 Swimming Pool Heat Pumps Location	6
3.3 Location & minimum clearances	6
3.4 Swimming Pool Heat Pumps Plumbing	7
3.5 Swimming Pool Heat Pumps Electrical Wiring	8
3.6 Initial Start-up of the Unit	8
4. Usage and Operation	9
4.1 Function of the controller	9
4.2 Usage of the controller	11
4.3 Parameter table	18
5. Maintenance and Inspection	19
5.1 Maintenance	19
5.2 Trouble Shooting Guide	20
6. Appendix	21
7. warranty	24
8. warranty registration.....	25

1. PREFACE

- In order to provide our customers with quality, reliability and versatility, this product has been made to strict production standards. This manual includes all the necessary information about installation, debugging, discharging and maintenance. Please read this manual carefully before you open or maintain the unit. The manufacture of this product will not be held responsible if someone is injured or the unit is damaged, as a result of improper installation, debugging, or unnecessary maintenance. It is vital that the instructions within this manual are adhered to at all times. The unit must be installed by qualified personnel.
- The unit can only be repaired by qualified installer centre, personnel or an authorised dealer.
- Maintenance and operation must be carried out according to the recommended time and frequency, as stated in this manual.
- Use genuine standard spare parts only.
Failure to comply with these recommendations will invalidate the warranty.
- Swimming Pool Heat Pump Unit heats the swimming pool water and keeps the temperature constant. For split type unit, The indoor unit can be Discretely hidden or semi-hidden to suit a luxury house.

Our heat pump has following characteristics:

1 Durable

The heat exchanger is made of PVC & Titanium tube which can withstand prolonged exposure to swimming pool water.

2 Installation flexibility

The unit can be installed outdoors or indoors.

3 Quiet operation

The unit comprises an efficient rotary/ scroll compressor and a low-noise fan motor, which guarantees its quiet operation.

4 Advanced controlling

The unit includes micro-computer controlling, allowing all operation parameters to be set. Operation status can be displayed on the LCD wire controller. Remote controller can be chosen as future option.

2.SPECIFICATION

2.2 The dimensions for Swimming Pool Heat Pump Unit

Model:Force 26

unit: mm

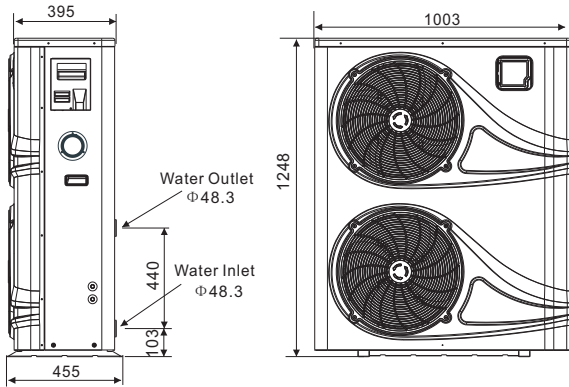
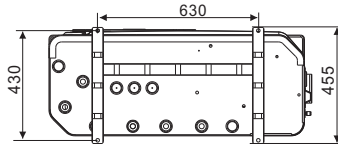

2.SPECIFICATION

Model:Force 26-3

unit: mm

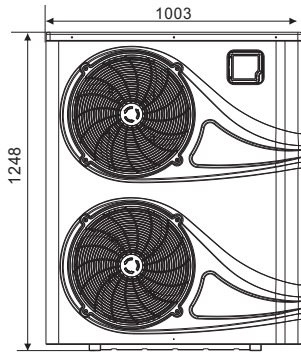
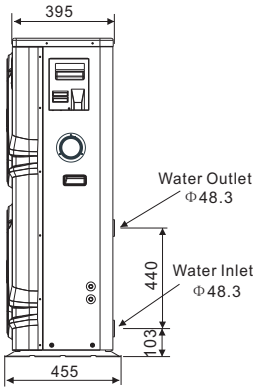
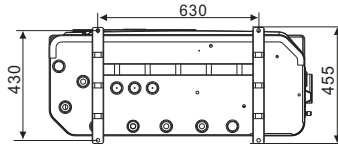

3.INSTALLATION AND CONNECTION

3.1 Installation illustration

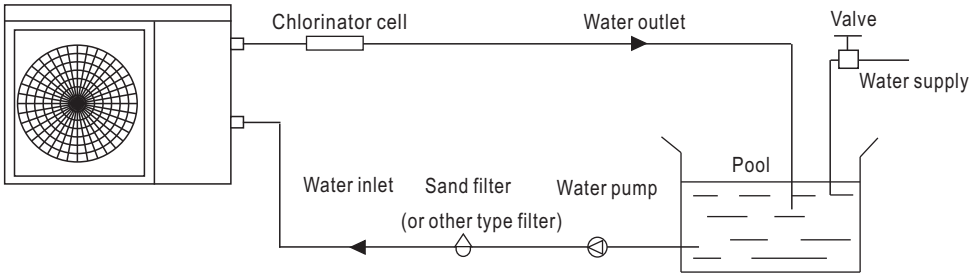

Installation items:

The factory only provides the main unit and the water unit; the other items in the illustration are necessary spare parts for the water system, that provided by users or the installer.

Attention:

Please follow these steps when using for the first time

1. Open valve and charge water.
2. Make sure that the pump and the water-in pipe have been filled with water.
3. Close the valve and start the unit.

ATTN: It is necessary that the water-in pipe is higher than the pool surface.

The schematic diagram is for reference only. Please check the water inlet/outlet label on the heat pump while plumbing installation.

3. INSTALLATION AND CONNECTION

3.2 Swimming Pool Heat Pumps Location

Before installation it is very important to ensure 4 variables are carefully checked to allow the unit to operate correctly:

- Adequate Air Flow
- Correct water flow volume
- Correct electrical connection & supply
- Heater condition

*For indoor pools please consult the supplier.

DO NOT place the unit in an enclosed area, where the units discharge air can be re-circulated. In an enclosed area take measures to evacuate the cold waste air out of the room. Conversely make sure there is adequate air entering the room to supply the heat pump.

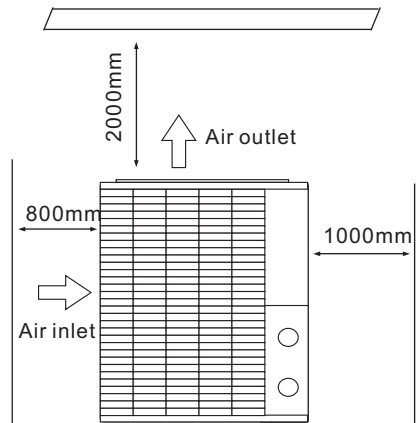
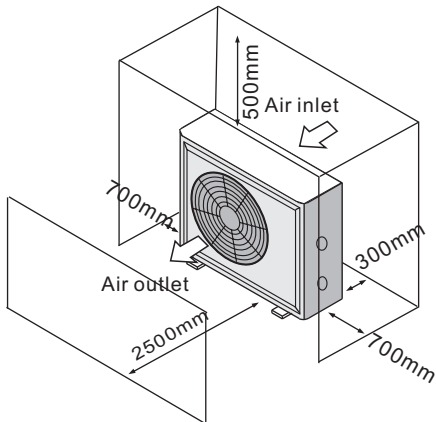

3.3 Location & minimum clearances

Evo recommend the heat pump should ONLY be installed in a location with appropriate ventilation. See above for minimum airflow clearances.

The Evo pool heat pump should be installed with a minimum clearance of at least 3.5m to the water's edge. Furthermore, EvoHeat recommend installing the heat pump no greater than 7.5 meters away from the water's edge due to heat loss from the piping. If you do not have a location with these suggested clearances, please contact our EvoHeat Tech Support Specialist on 1300 859 933 to discuss appropriate installation locations.

The heat pump should be installed a maximum of 5m below the water level of the pool/spa.

Make sure the heat pump is not located where large amounts of water may run-off from a roof into the unit. Sharp sloping roofs without gutters will allow excessive amounts of rain water mixed with debris from the roof to be forced through the unit. A water deflector may be needed to protect the heat pump.

If installing the heater on an existing pump/filtration system the heater must be installed AFTER the filter and BEFORE the chlorinator/sanitizer.

The heat pump should be installed on a flat level surface. In the event that a suitable location is unavailable contact Evo Industries for specialist technical advice.

3. INSTALLATION AND CONNECTION

3.4 Swimming Pool Heat Pumps Plumbing

The Swimming Pool Heat Pumps exclusive rated flow titanium heat exchanger requires no special plumbing arrangements except bypass (please set the flow rate according to the nameplate). The water pressure drop is less than 10kPa at max. Flow rate. Since there is no residual heat or flame Temperatures, The unit does not need copper heat sink piping. PVC pipe can be run straight into the unit.

Location: Connect the unit in the pool pump discharge (return) line downstream of all filter and pool pumps, and upstream of any chlorinators, ozonators or chemical pumps.

Standard model have slip glue fittings which accept 32mm or 50 mm PVC pipe for connection to the pool or spa filtration piping. By using a 50 NB to 40NB you can plumb 40NB

Give serious consideration to adding a quick coupler fitting at the unit inlet and outlet to allow easy draining of unit for winterizing and to provide easier access should servicing be required.

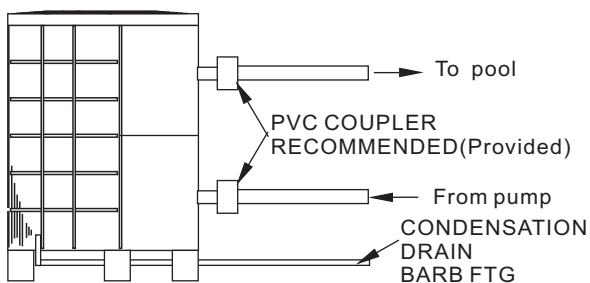

Condensation: Since the Heat pump cools down the air about 4 -5°C, water may condense on the fins of the horseshoe shaped evaporator. If the relative humidity is very high, this could be as much as several litres an hour. The water will run down the fins into the basepan and drain out through the barbed plastic condensation drain fitting on the side of the basepan. This fitting is designed to accept 20mm clear vinyl tubing which can be pushed on by hand and run to a suitable drain. It is easy to mistake the condensation for a water leak inside the unit.

NB: A quick way to verify that the water is condensation is to shut off the unit and keep the pool pump running. If the water stops running out of the basepan, it is condensation. AN EVEN QUICKER WAY IS to TEST THE DRAIN WATER FOR CHLORINE - if there is no chlorine present, then it's condensation.

3. INSTALLATION AND CONNECTION

3.5 Swimming Pool Heat Pumps Electrical Wiring

NOTE: Although the unit heat exchanger is electrically isolated from the rest of the unit, it simply prevents the flow of electricity to or from the pool water. Grounding the unit is still required to protect you against short circuits inside the unit. Bonding is also required.

The unit has a separate molded-in junction box with a standard electrical conduit nipple already in place. Just remove the screws and the front panel, feed your supply lines in through the conduit nipple and wire-nut the electric supply wires to the three connections already in the junction box (four connections if three phase). To complete electrical hookup, connect Heat Pump by electrical conduit, UF cable or other suitable means as specified (as permitted by local electrical authorities) to a dedicated AC power supply branch circuit equipped with the proper circuit breaker, disconnect or time delay fuse protection.

Disconnect - A disconnect means (circuit breaker, fused or un-fused switch) should be located within sight of and readily accessible from the unit. This is common practice on commercial and residential air conditioners and heat pumps. It prevents remotely-energizing unattended equipment and permits turning off power at the unit while the unit is being serviced.

3.6 Initial startup of the Unit

NOTE- In order for the unit to heat the pool or spa, the filter pump must be running to circulate water through the heat exchanger.

Start up Procedure - After installation is completed, you should follow these steps:

1. Turn on your filter pump. Check for water leaks and verify flow to and from the pool.
2. Turn on the electrical power supply to the unit, then press the key ON/OFF of wire controller. It should start in several seconds.
3. After running a few minutes make sure the air leaving the top(side) of the unit is cooler (Between 5-10 °C)
4. With the unit operating turn the filter pump off. The unit should also turn off automatically.
5. Allow the unit and pool pump to run 24 hours per day until desired pool water temperature is reached. When the water-in temperature reach setting, The unit just shuts off. The unit will now automatically restart (as long as your pool pump is running) when the pool temperature drops more than 2°C below set temperature.

Time Delay- The unit is equipped with a 3 minute built-in solid state restart delay included to protect control circuit components and to eliminate restart cycling and contactor chatter. This time delay will automatically restart the unit approximately 3 minutes after each control circuit interruption. Even a brief power interruption will activate the solid state 3 minute restart delay and prevent the unit from starting until the 5 minute countdown is completed. Power interruptions during the delay period will have no effect on the 3 minute countdown.

4. USAGE AND OPERATION



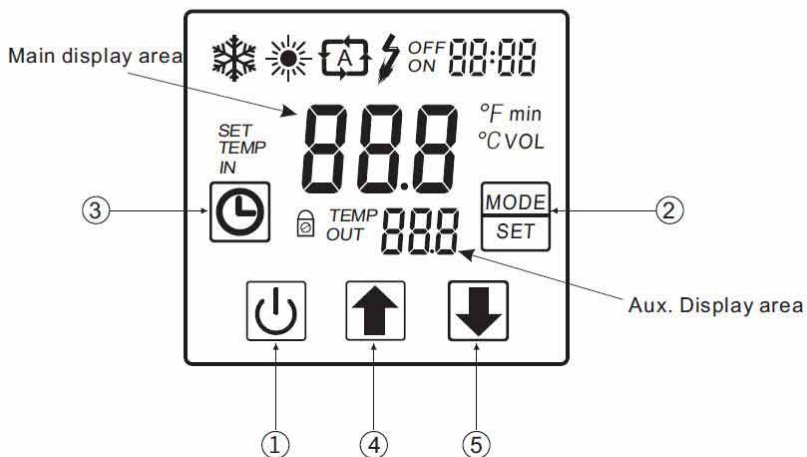

1. Function of controller



1) Button function

NO	Symbol	Name	Function
①		On/off	Press this button can start up or shut down the unit, cancel the current operation or back to the upper interface
②		Mode	Press this button can switch modes or save parameter setting.
③		Clock	Press this button can set the clock and timer
④		Up	Press this button can move up or increase parameter value.
⑤		Down	Press this button can move down or decrease the parameter value.



4. USAGE AND OPERATION

Symbol	Meaning	Function
	Cooling	It is showed when the unit in cooling mode.
	Heating	It is showed when the unit in heating mode and flashed in defrosting.
	Automatic	It is showed when the unit in automatic mode.
	Electric-heating	It is showed when the unit in electric-heating mode. (Swimming pool unit without this display)
ON	Timer on	It is showed when the unit sets the timer on
OFF	Timer off	It is showed when the unit sets the timer off
IN	Inlet water	It is showed when the main display area gives the inlet water temperature.(measured value)
OUT	Outlet water	It is showed when the AUX display area gives the outlet water temperature.(measured value)
TEMP	Temperature	It is showed when the main/ AUX display area gives temperature
VOL	Flow	It is showed when the main display area gives the water flow value
min	Minute	It is showed when the main display area gives minute value
°F	Fahrenheit	It is showed when the main/AUX display area gives Fahrenheit value
°C	Centigrade	It is showed when the main/AUX display area gives centigrade value
SET	Parameter setting	It is showed when the parameter can be setted.
	Lock	It is showed when the keyboard is locked.

4. USAGE AND OPERATION

2. The controller usage

2.1 Starting up and shutting down

In the off interface, press "  " for 0.5s can start up the unit, and aux. display-area shows water outlet temperature; In the running interface, press "  " for 0.5s can shut down the unit and aux. display-area shows "OFF" .

Attention: the operation of Starting up and shutting down can only be done in the main interface. For example:

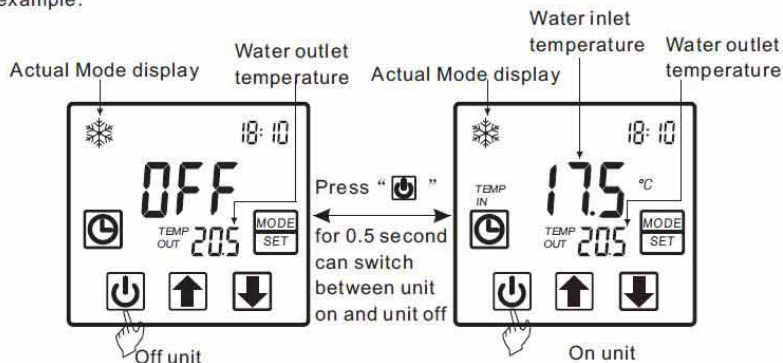

2.2 Modes switching

If it is cold/heat unit, in the main interface, you can switch different modes of cooling, heating, auto mode by pressing "  " .

Attention: The modes switching is useless if the unit you buy is single-cold/ single-heat unit. For example:

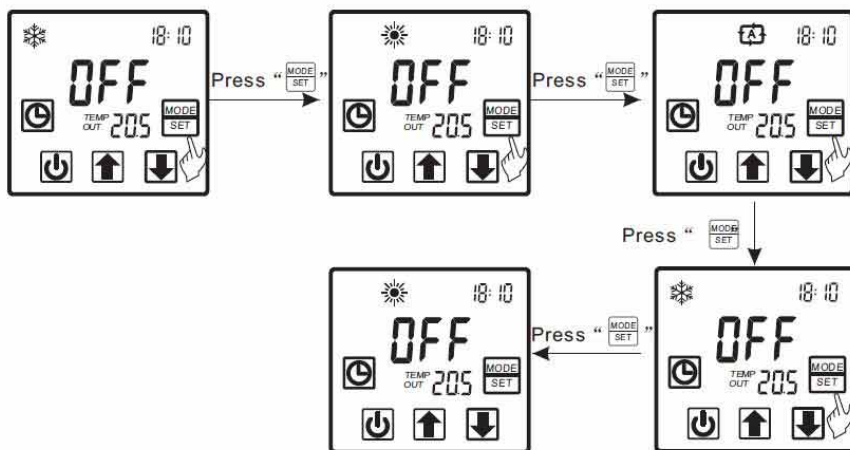

4. USAGE AND OPERATION

2.3 Temperature setting

In the main interface, press “

Press “

Press “

Attention: If there is no operation for 5s. system would remember parameter setting and back to the main interface.

For example:

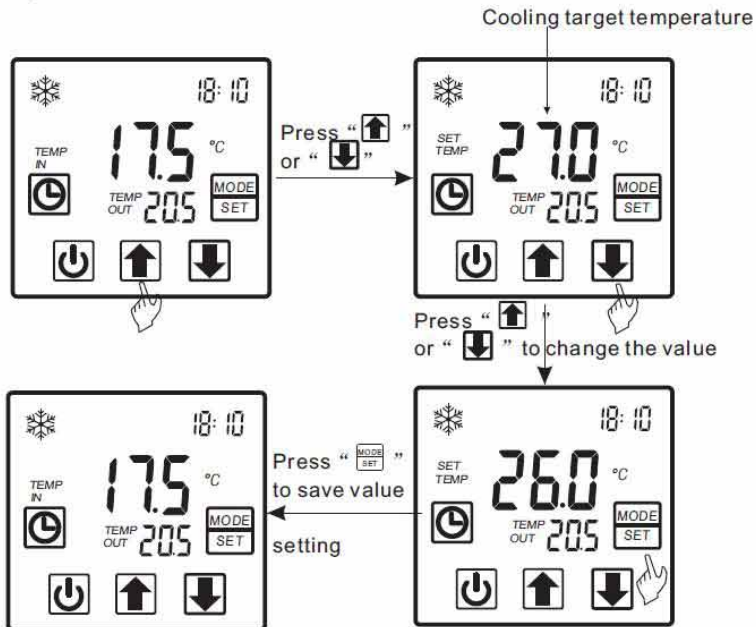

2.4 Clock setting

In the main interface, press “

At the same time, minute start to flashing, press “

Press “

Attention: If there is no operation for 5s system will remember parameter setting and back to the main interface.

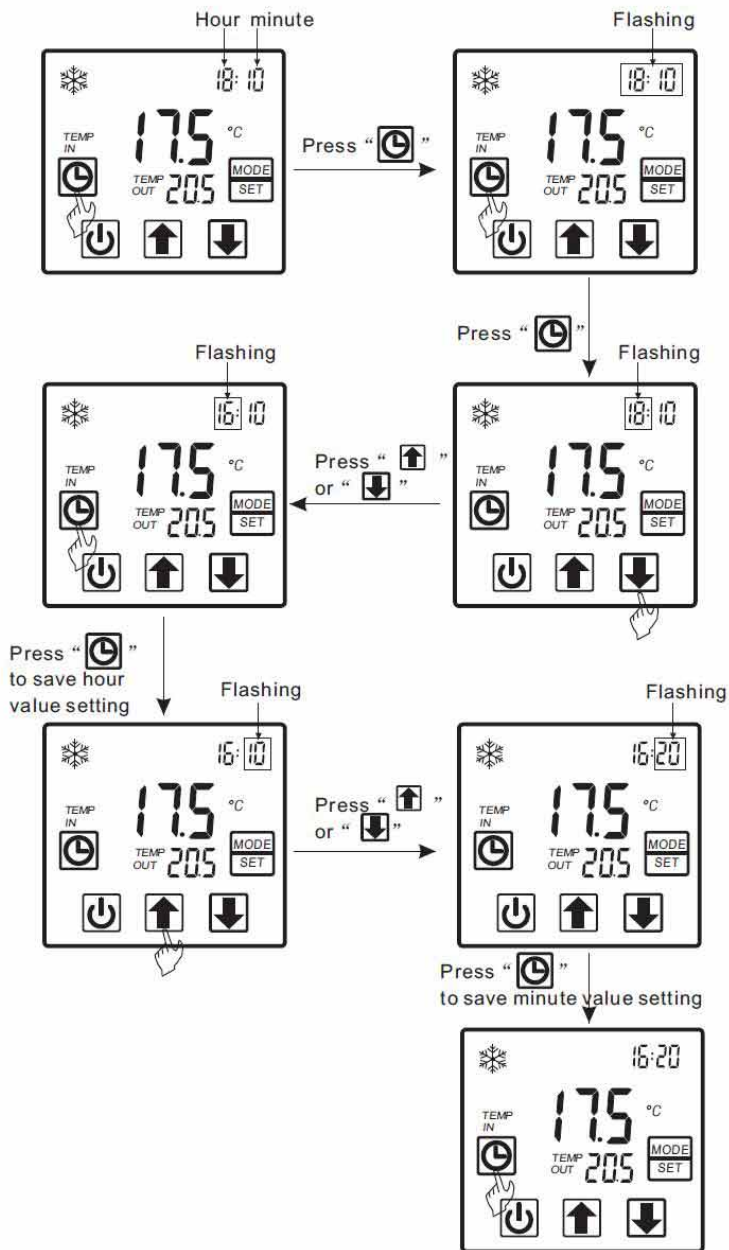

For example:

4. USAGE AND OPERATION



4. USAGE AND OPERATION

2.5 Timer setting

In the main interface, press “” hold on 2 seconds and "on" is flashing, at this time, you can set the timer (means the unit timer is on), then press “” again and hold on 2 seconds and "off" is flashes you can set the timer off (means the unit timer is off).

If you want cancel the timer off, In the "off" flashing interface, press “” to cancel

Attention: 1) If there is no operation for 5s. system will remember clock setting and back to the main interface.

2) By pressing “” till the "off" flashing, you can set the timer off without timer on.

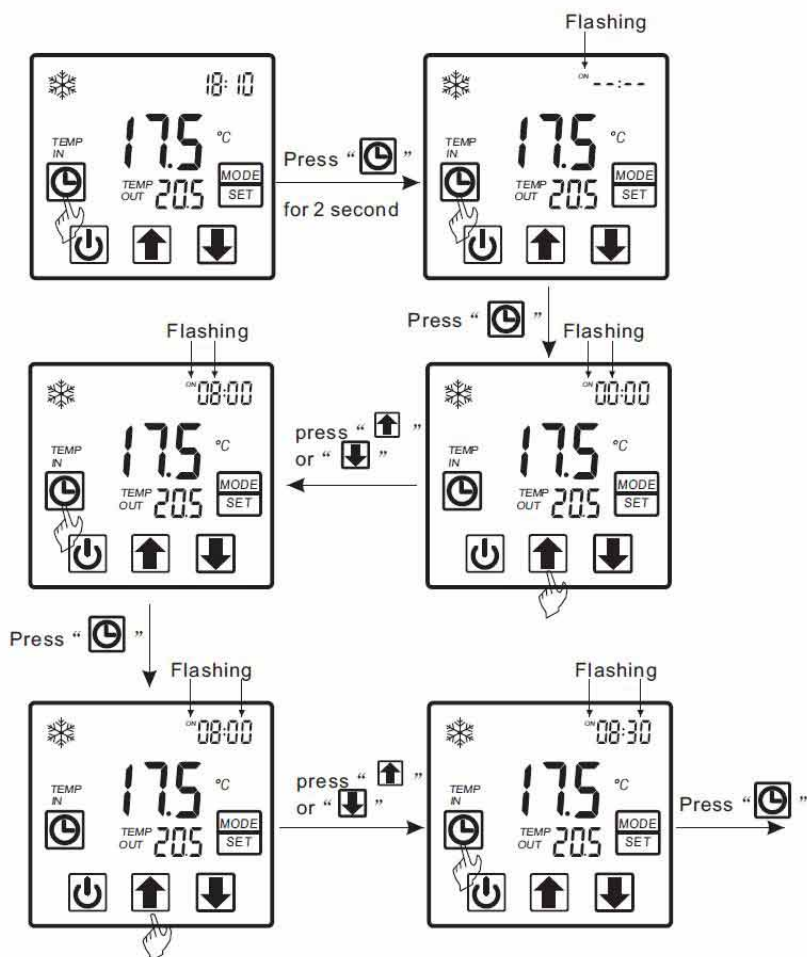

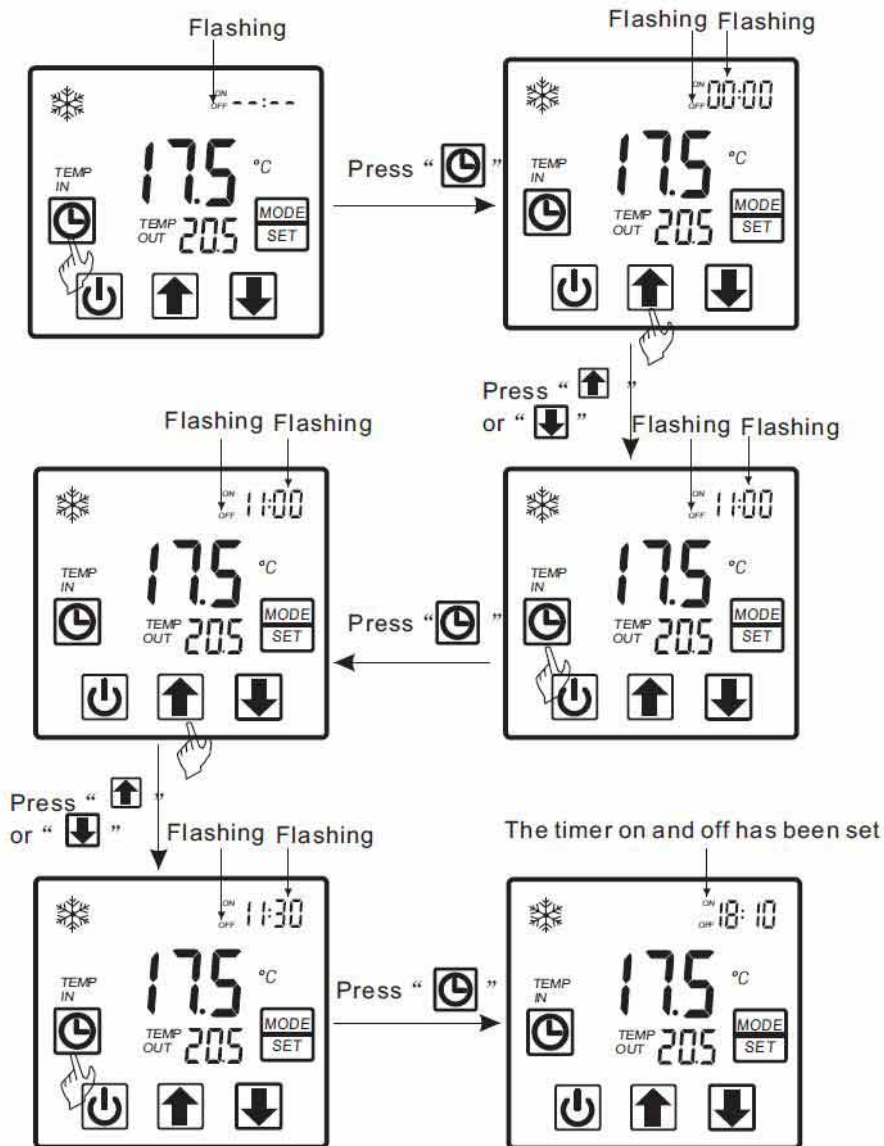

4. USAGE AND OPERATION



4. USAGE AND OPERATION

2.6 Cancel the timer setting

Press “” for 2s and “ON” is flashing, at this time, press “” to cancel the setting of timer on; It is the same way to cancel the setting of timer off .

For example:

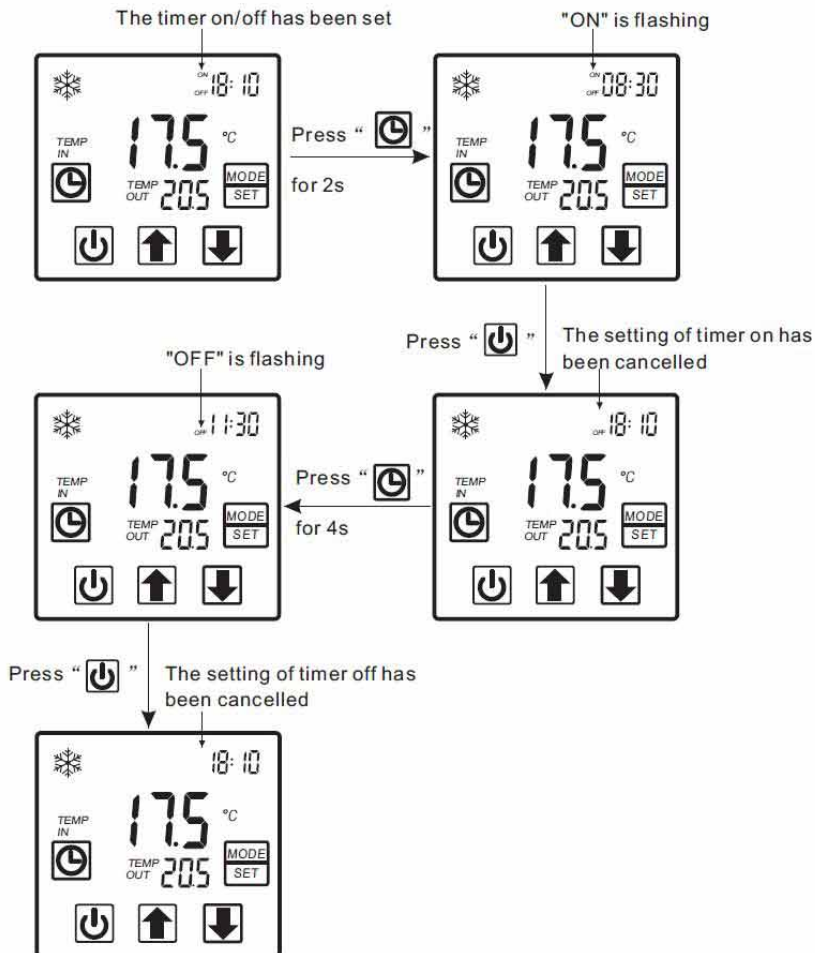

4. USAGE AND OPERATION

2.4 Keyboard lock

To avoid mis-operation, please lock the controller after parameter setting.

At the main interface, press “” for 5 seconds, the keyboard will be locked.

When the keyboard is locked, press “” for 5 seconds, the keyboard will be unlocked.

NOTES: When the unit is in alarming state, the key lock can be removed automatically.

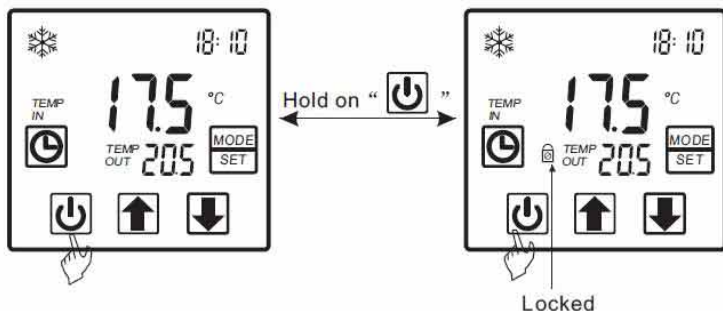

2.5 Malfunction display

There will be malfunction code showing on the controller screen when relative malfunction occurs.

You can refer to the malfunction table to find out the failure cause and solution.

For example”

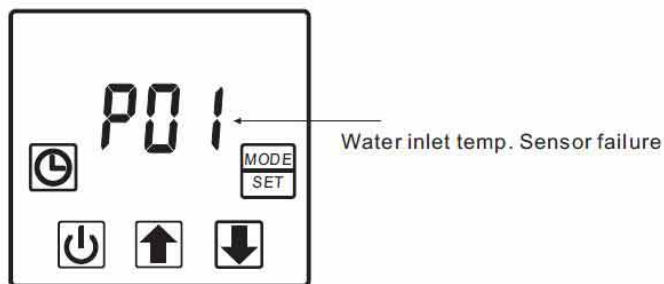

4. USAGE AND OPERATION

3. Parameter table

Meaning	Default	Remark
Heating inlet target temp.	27°C	Adjustable
Cooling inlet target temp.	27°C	Adjustable
Auto inlet target temp.	27°C	Adjustable

Remark:

The wire controller can display the temperature unit as "°F" or "°C" according to the unit Model you bought.

5. MAINTENANCE AND INSPECTION

Do I need to get my unit serviced regularly?

It is recommended that you get your EvoHeat unit serviced once a year by your local certified air conditioning or refrigeration technician. If your unit is located in a coastal area, more frequent maintenance may be necessary. During the service, they will check the operational pressures of the refrigeration system and give the unit and fins a good clean to ensure maximum performance.

Do we have recommended service agents?

EvoHeat have a large database of recommended service agents. Please contact EvoHeat tech support on 1300 859 933 for your local service agent details.

Should I check my unit regularly?

We recommend you check your unit regularly to avoid potential issues and damage to your heat pump.

What should I check?

Check the water inlet/outlets often for leaks. You should avoid the condition of no water or air entering into the system, as this will influence unit's performance and reliability.

You should clear the pool/spa filter regularly to avoid damage to the unit as a result of the dirty or clogged filter.

The area around the unit should be dry, clean and well ventilated. Make sure there is nothing blocking the airflow of the heater e.g. Leaf litter.

Discharge all water in the water pump and water system, so that freezing of the water in the pump or water system does not occur. You should discharge the water at the bottom of water pump if the unit will not be used for an extended period. You should check the unit thoroughly and fill the system with water fully before using it for the first time after a period of time.

Check the power supply and cable connection often, should the unit begin to operate abnormally, switch it off and contact the qualified technician

5. MAINTENANCE AND INSPECTION

5.2 Trouble Shooting Guide

The common failure cause and solution.

CODE	FAILURE	REASON	SOLUTION
P01	Water inlet temp. sensor failure	The water inlet temperature sensor is open or short circuit or the water temperature sensor is loose or faulty	Check or change the water inlet temperature sensor
P02	Water outlet temp. sensor failure	The water outlet temperature sensor is open or short circuit or the water temperature sensor is loose or faulty	Check or change the water outlet temperature sensor
P04	Ambient temp. sensor failure	The ambient temperature sensor is open or short circuit	Check or change the ambient temperature sensor
P05	Coil temp. sensor failure	Temp. Sensor is loose or faulty	Check or change the sensor
P07	Suction temp. sensor 1 failure	Temp. Sensor is loose or faulty	Check or change the sensor
P08	Exhaust temp sensor failure	The exhaust temp. sensor is open or short circuit	Check or change the temp sensor
E01	High pressure protection (HP)	HP switch is loose or faulty. Low water flow	Check or change the sensor. Check water flow of system
E02	Low pressure protection (LP)	LP switch is loose or faulty. Loss of refrigerant.	Check or change the sensor. Check Pressure gauges.
E03	Water flow protection	Flow switch is loose or faulty. Low water flow	Check or change the sensor. Check water flow of system
E06	Temp. difference between inlet and outlet	Temp. difference >13	Temp. difference >13, power off
E07	Antifreezing protection	Antifreezing temp. <2	Check flow and water system
E08	Communication failure	Communication failure between wire controller and main board	Check the connection between wire controller and main board
E19	Primary Antifreezing protection	Ambient temp. is too low	/
E29	Secondary Antifreezing protection	Ambient temp. is too low	/

6.APPENDIX

1.Connection of PCB illustration

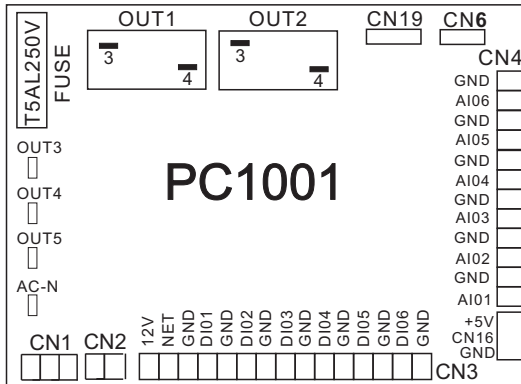

Connections explanation:

No.	Symbol	Meaning
1	OUT1	Compressor of system1 (220-230VAC)
2	OUT2	Water pump (220-230VAC)
3	OUT3	4way valve (220-230VAC)
4	OUT4	High speed of fan motor (220-230VAC)
5	OUT5	Low speed of fan motor (220-230VAC)
6	AC-N	Neutral wire
7	NET GND 12V	Wire controller
8	DI01 GND	On/Off Switch(input)(no use)
9	DI02 GND	Flow switch (input)(normal close)
10	DI03 GND	Low pressure protect
11	DI04 GND	High pressure protect
12	DI05 GND	No use
13	DI06 GND	No use
14	AI01 GND	Suction temp.(input)
15	AI02 GND	Water in temp.(input)
16	AI03 GND	Water out temp.(input)
17	AI04 GND	Temp. Of coil (input)
18	AI05 GND	Ambient temp.(input)
19	AI06 GND	Adjustable fan speed/Exhaust temperature
20	CN1	Primary transformer
21	CN2	Secondary transformer
22	CN6	Without use
23	CN19	Electronic expansion valve
24	5V CN16 GND	Flow meter

6.APPENDIX

Caution & Warning

1. The unit can only be repaired by qualified installer centre personnel or an authorised dealer. (for Europe market)
2. This appliance is not intended for use by persons (including children) with reduced physical sensory or mental capabilities, or lack of experience and knowledge, unless they have been given supervision or instruction concerning use of the appliance by a person responsible for their safety. (for Europe market)
Children should be supervised to ensure that they do not play with the appliance.
3. Please make sure that the unit and power connection have good earthing, otherwise may cause electrical shock.
4. If the supply cord is damaged, it must be replaced by the manufacturer or our service agent or similarly qualified person in order to avoid a hazard.
5. Directive 2002/96/EC (WEEE):
The symbol depicting a crossed-out waste bin that is underneath the appliance indicates that this product, at the end of its useful life, must be handled separately from domestic waste, must be taken to a recycling centre for electric and electronic devices or handed back to the dealer when purchasing an equivalent appliance.
6. Directive 2002/95/EC (RoHs): This product is compliant with directive 2002/95/EC (RoHs) concerning restrictions for the use of harmful substances in electric and electronic devices.
7. The unit CANNOT be installed near the flammable gas. Once there is any leakage of the gas , fire can be occur.
8. Make sure that there is circuit breaker for the unit, lack of circuit breaker can lead to electrical shock or fire.
9. The heat pump located inside the unit is equipped with an over-load protection system. It does not allow for the unit to start for at least 3 minutes from a previous stoppage.
10. The unit can only be repaired by the qualified personnel of an installer center or an authorized dealer. (for North America market)
11. Installation must be performed in accordance with the NEC/CEC by authorized person only. (for North America market)
12. USE SUPPLY WIRES SUITABLE FOR 75°C.
13. Caution: Single wall heat exchanger, not suitable for potable water connection.

6.APPENDIX

(2) Cable specification

1. Single phase unit

Nameplate maximum current	Phase line	Earth line	MCB	Creepage protector	Signal line
No more than 10A	$2 \times 1.5\text{mm}^2$	1.5mm^2	20A	30mA less than 0.1 sec	$n \times 0.5\text{mm}^2$
10~16A	$2 \times 2.5\text{mm}^2$	2.5mm^2	32A	30mA less than 0.1 sec	
16~25A	$2 \times 4\text{mm}^2$	4mm^2	40A	30mA less than 0.1 sec	
25~32A	$2 \times 6\text{mm}^2$	6mm^2	40A	30mA less than 0.1 sec	
32~40A	$2 \times 10\text{mm}^2$	10mm^2	63A	30mA less than 0.1 sec	
40~63A	$2 \times 16\text{mm}^2$	16mm^2	80A	30mA less than 0.1 sec	
63~75A	$2 \times 25\text{mm}^2$	25mm^2	100A	30mA less than 0.1 sec	
75~101A	$2 \times 25\text{mm}^2$	25mm^2	125A	30mA less than 0.1 sec	
101~123A	$2 \times 35\text{mm}^2$	35mm^2	160A	30mA less than 0.1 sec	
123~148A	$2 \times 50\text{mm}^2$	50mm^2	225A	30mA less than 0.1 sec	
148~186A	$2 \times 70\text{mm}^2$	70mm^2	250A	30mA less than 0.1 sec	
186~224A	$2 \times 95\text{mm}^2$	95mm^2	280A	30mA less than 0.1 sec	

2. Three phase unit

Nameplate maximum current	Phase line	Earth line	MCB	Creepage protector	Signal line
No more than 10A	$3 \times 1.5\text{mm}^2$	1.5mm^2	20A	30mA less than 0.1 sec	$n \times 0.5\text{mm}^2$
10~16A	$3 \times 2.5\text{mm}^2$	2.5mm^2	32A	30mA less than 0.1 sec	
16~25A	$3 \times 4\text{mm}^2$	4mm^2	40A	30mA less than 0.1 sec	
25~32A	$3 \times 6\text{mm}^2$	6mm^2	40A	30mA less than 0.1 sec	
32~40A	$3 \times 10\text{mm}^2$	10mm^2	63A	30mA less than 0.1 sec	
40~63A	$3 \times 16\text{mm}^2$	16mm^2	80A	30mA less than 0.1 sec	
63~75A	$3 \times 25\text{mm}^2$	25mm^2	100A	30mA less than 0.1 sec	
75~101A	$3 \times 25\text{mm}^2$	25mm^2	125A	30mA less than 0.1 sec	
101~123A	$3 \times 35\text{mm}^2$	35mm^2	160A	30mA less than 0.1 sec	
123~148A	$3 \times 50\text{mm}^2$	50mm^2	225A	30mA less than 0.1 sec	
148~186A	$3 \times 70\text{mm}^2$	70mm^2	250A	30mA less than 0.1 sec	
186~224A	$3 \times 95\text{mm}^2$	95mm^2	280A	30mA less than 0.1 sec	

When the unit will be installed at outdoor, please use the cable which can against UV.

Please refer to the EvoHeat website for warranty details

- Australia: www.evoheat.com.au
 - South East Asia: www.evoheat.com.sg
2. Warranty terms are from date of purchase.
 3. This warranty excludes any defect or injury caused by or resulting from misuse, abuse, neglect, accidental damage, improper voltage, vermin infestation, incompetent installation, any fault not attributable to faulty manufacture or parts, any modifications which affect the reliability or performance of the unit.
 4. This warranty does not cover the following:
 - a. Natural Disasters (hail, lightening, flood, fire etc.)
 - b. Rust or damage to paintwork caused by a corrosive atmosphere
 - c. When serviced by an unauthorized person without the permission of Evo Industries
 - d. When a unit is installed by an unqualified person
 - e. Where a unit is incorrectly installed
 - f. When failure occurs due to improper or faulty installation
 - g. Failure due to improper maintenance (refer Operating Instructions)
 - h. 'No Fault Found' service calls where the perceived problem is explained within the
 - i. Costs associated with delivery, handling, freighting, or damage to the product in transit.
 5. If warranty service is required you should:
 - a. contact Evo Industries Australia on 1300 859 933 or via our Contact page on our web site
 - b. provide a copy of your receipt as proof of purchase
 - c. have completed the online warranty registration or provide a completed warranty card.
 6. Onsite technical service is available within the normal operating area of your Evo Industries authorized Service Centre. Service outside this area will incur a traveling fee.
 7. Unless otherwise specified to the purchaser, the benefits conferred by this express warranty and additional to all other conditions, warranties, rights and remedies expressed or implied by the Trade Practices Act 1974 and similar consumer protection provisions contained in legislation of the States and Territories and all other obligations and liabilities on the part of the manufacturer or supplier and nothing contained herein shall restrict or modify such rights, remedies, obligations or liabilities.

Warranty Registration

To register your Warranty, please enter the following details or go online at <https://evoheat.com.au/warranty-registration/> to register directly at our website.

Fields with a star (*) must be filled in. For information about what Evo Industries Australia will do with your personal details, please refer to our Privacy Disclaimer on our website.

Family Name: * _____

Given Name: * _____

Preferred Title: * _____

Age Group: * 18-24 25-34 35-44 45-54 55-64 64+

Street Address: * _____

Suburb: * _____

Postcode: * _____

State: * _____

Email: * _____

Please tell us about which EvoHeat product you bought, who you bought it from and what you will be using it for.

Product & Model: * _____

Serial Number: * _____

Authorised Installer: * _____

Date Purchased: * _____

Date Installed: * _____

Receipt Number: * _____

Company you bought it from: * _____

Did you purchase the item when you purchased your pool?: _____

If you purchased it after the pool, how many years did you wait?: _____

What size is your pool or spa?: _____

Why did you choose an EVOHEAT product? _____