



Evo270

Installation & Operation Manual



Contents

1. Introduction _____ 2

2. Quick Start Guide _____ 3

3. Unit Specifications _____ 4

 3.1 Dimensions & Technical Data _____ 4

4. Safety Instructions _____ 5

5. Installation _____ 5

 5.1 Pipeline Connection _____ 5

 5.2 Handling & Transportation _____ 6

 5.2 Location of Install & Minimum Clearances _____ 6

 5.3 Cable Connection _____ 7

 5.4 Filling the Tank _____ 7

 5.5 Initial Start-up of the Unit _____ 8

6. Operation _____ 8

 6.1 Main Controller Interface _____ 9

 6.2 Functions of the Controller _____ 10

 6.2.1 Turning the Unit ON & OFF _____ 10

 6.2.2 Mode Selection _____ 10

 6.2.3 Target Temperature Checking & Setting _____ 11

 6.2.4 Setting the Date & Time _____ 11

 6.2.5 Using the Timer _____ 12

 6.2.6 Vacation Mode _____ 13

 6.2.7 Hydropower Setting _____ 13

 6.2.8 Using Fan Mode _____ 13

 6.2.8 Adjusting the Hydro Power Booster _____ 14

 6.2.9 Adjusting the Sanitech System _____ 14

 6.2.10 Locking the Keyboard _____ 14

7. Troubleshooting _____ 15

8. Appendix _____ 16

 8.1 Parameter List _____ 16

 8.2 PCB Description _____ 16

 8.3 Detailed Parts Overview _____ 18

 8.4 Caution _____ 20

 8.5 Earthing Methodology _____ 20

 8.6 Use of the P&T Valve _____ 20

 8.7 Using the Overheating Protector _____ 21

 8.8 Draining the Water Tank _____ 21

9. Maintenance _____ 22

10. Warranty _____ 23



1. Introduction

This manual contains all the necessary information in regard to the installation, troubleshooting, operation and maintenance of this unit. Ensure instructions in this manual are adhered to at all times. Failing to comply with these recommendations will invalidate the warranty. This manual and all others are available for download on our website.



The EVO 270 is the next evolution in water heating, with advanced energy efficiency technologies and built in smart features to ensure you're provided with clean, safe, and economical hot water all year round. Unlike traditional hot water systems that use 1kW of energy to produce 1kW of heat, the EVO 270 utilises that very same 1kW of energy and heat pump technology to generate 4kW of heat – saving you up to 75% of your hot water costs!

- When installing the Evo 270, follow all instructions as documented in this manual.
- Once the installation is complete, check that all connections are secure before the power is turned on.
- The installer is to explain to the end user how to operate and maintain the unit in accordance with this instruction manual.
- Evo Industries Australia Pty Ltd will not be held responsible for any damages or injuries caused by the incorrect installation of this hot water system.
- A maintenance programme must be carried out as recommended in this manual to ensure ongoing reliability.
- Failure to comply with these recommendations could void the warranty and cause injury or death.
- Due to continuous product improvement, this manual may be subject to change without prior notice.

Recommended Household Size

The below recommendations are based on heat pump only mode.













Higher occupancy levels are able to be achieved with the Hydroboost heater activated.

Household Size	Model
Up to 6 People	Evo 270

Notice: High usage of hot water and other factors could affect this recommendation. Please consult your supplier if you have special requirements.

QUICK START GUIDE

INITIAL SET UP

1. Press and hold  for one second to power on the unit.
2. To set the time:
 - a. Press  once so the clock starts flashing,
 - b. Press  again until the hour starts flashing,
 - c. Use   to adjust the hour and press  to confirm,
 - d. Repeat for the minute, day, month and year,
 - e. Press  at any stage to cancel.
3. Press  until  is displayed. This will activate “Eco Heating” (Heat Pump only) mode and will provide the most efficient heating.
4. During periods of unusually high hot water demand (such as additional occupants staying with you), you can activate “Dual Heating” mode by pressing  until  is displayed.
5. In any event where there is a failure within the system, the Electric Element can be engaged with “one push activation” of the  button until  is displayed. This will provide emergency water heating until service can be attended.
6. For adjustment of timers or activating vacation mode, please refer to our online tutorials at:
www.evoheat.com.au



Do not drill any fixings or attachments into the outer casing of the tank. Drilling into the outer casing of the tank may damage the heating coil and WILL VOID WARRANTY.

**FOR ADDITIONAL INFORMATION
SEE THE REST OF THIS MANUAL**

3. Unit Specifications

How it Works

- Refrigerant is compressed into vapor with high temperature and high pressure when it goes through the compressor.
- On the discharge side of the compressor, the now hot and highly pressurized vapor is cooled down through the heat exchange with the water in the tank until it condenses into a high pressure, moderate temperature liquid.
- The pressure of the liquid refrigerant drops as it passes the throttling device.
- Finally, the refrigerant absorbs the heat from the surrounding air and evaporates into vapor with low temperature and low pressure, where it then it goes into the compressor again.

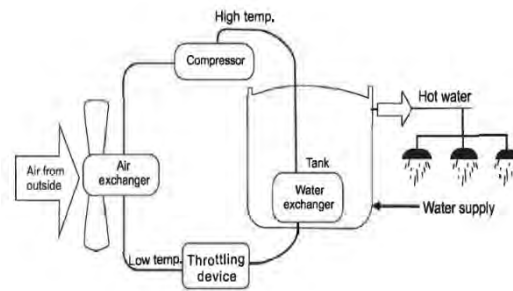

3.1 Dimensions & Technical Data

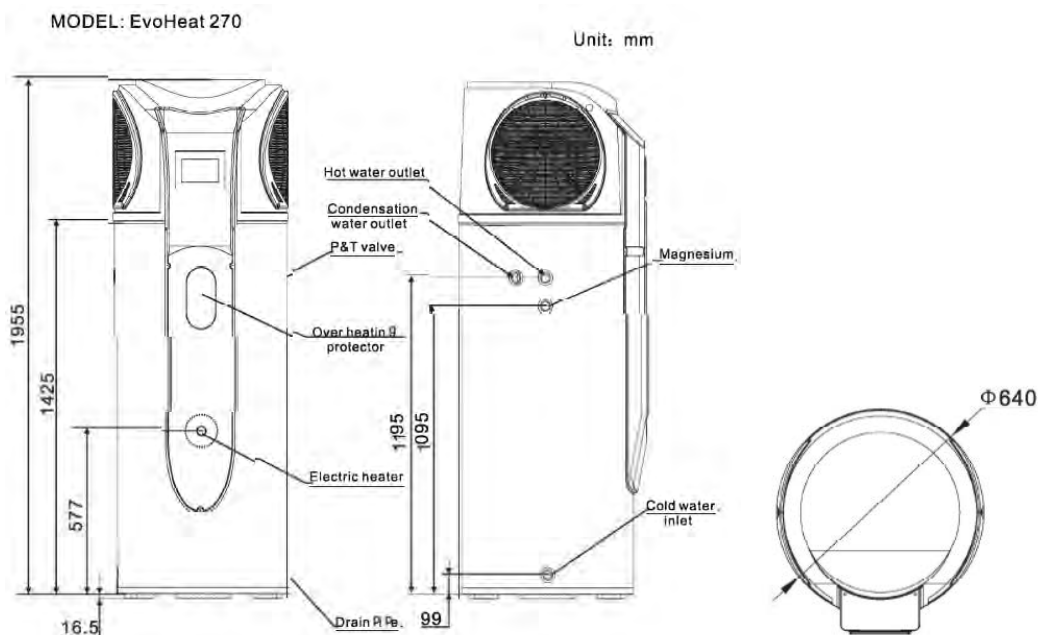

Model		Evo 270
Heating capacity	kW	3.4 Heat Pump
Water tank capacity		270
Power input	kW	0.94 Heat Pump
Running current	A	3.92 Heat Pump + 6.5 Hydroboost
Power Supply		240V~/50Hz
Compressor Number		1
Compressor		Rotary
Rated outlet water temp.	Deg C	55
Air Volume	m ³ /h	450
Noise	dB(A)	49
Water inlet/outlet size	inch	¾
*Hydroboost power heat	kW	1.5
Net dimensions	mm	See the drawing
Shipping Dimensions	mm	720x760x2040
Net Weight	kg	135
Shipping weight	kg	175

Measurement conditions:

Instant heating: Ambient temperature 15DB/13WB, Water inlet 15 Water outlet 45

Working Temp Range

- 1) Ambient temperature is -7deg to 43deg (Heat Pump)
- 2) The max temperature of water tank is 70

Operating parameters: The range of the operating water pressures: 0.15~0.7MPa

4. Safety Instructions

- ✓ A qualified technician is required to install, relocate the unit if required and for all repairs.
- ✓ Good earthing is required for both the unit and power connections to prevent electrical shock.
- ✓ Ensure that there are no leaks on both the plumbing and drainage fittings.
- ✓ The unit must not be installed near flammable gas or have flammable aerosols sprayed in the vicinity.
- ✓ The base that the unit is installed on must be level and stable.
- ✓ A circuit breaker is required to be installed with this unit.
- ✓ Fingers and objects must not be placed into the fan of the unit. Children should be kept clear of the appliance.
- ✓ In the event of the unit malfunctioning, shut off the power supply and contact your supplier or EvoHeat.
- ✓ Power the unit off during cleaning.
- ✓ The unit produces hot water and will also have hot fittings, therefore should not be touched to avoid injury.

5. Installation

5.1 Pipeline Connection

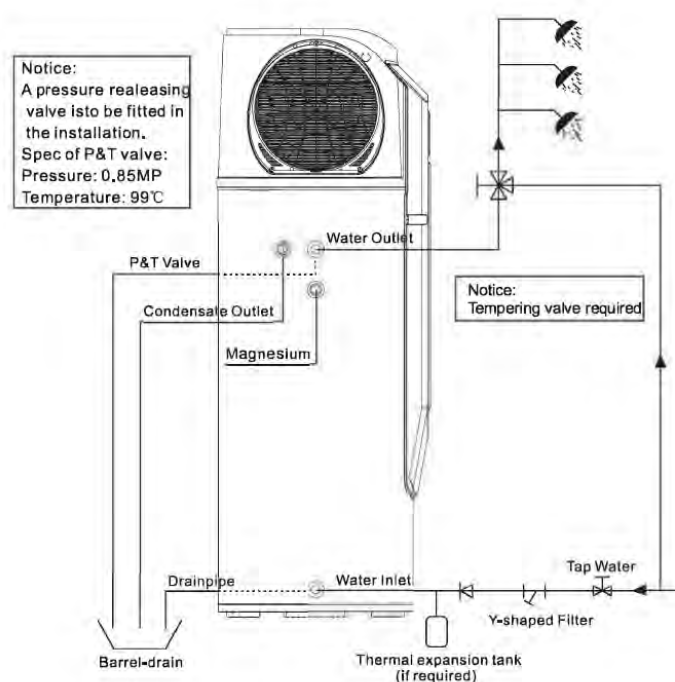

Installation of the water inlet or outlet pipes: The specification of the water inlet and outlet thread is BSP3/4(internal thread). Pipes must be heat-resistant and durable.

Installation of the pipe for P&T valve: The spec of the valve connecting thread is BSP3/4(internal thread). After installation, it must be confirmed that the drainpipe outlet is exposed in the air. When the flexible drainpipe is joined to the pressure relief orifice of this valve, you must ensure that the flexible drainpipe is pointing downwards and exposed in the air.

ATTENTION

- Do not drill any fixings or attachments into the outer casing of the tank. Drilling into the outer casing of the tank may damage the heating coil and **WILL VOID WARRANTY.**
- The P&T valve attached with the unit must be installed. Failure to do so will cause damage to the unit and possible personal injury.
- Do not use stainless steel fittings to connect directly with other metals to prevent galvanic corrosion.
- Drain the water tank through the drain valve at the bottom part of the unit.

5.2 Handling & Transportation

As a rule, the unit should be stored and/or transported in its shipping container in an upright position and without water charge. For transport over short distances, and provided due care is exercised, an inclination angle of up to 30 degrees is permitted. During transport and storage, ambient temperatures of -10 to +60 degrees Celsius are permissible.

Forklift Transportation

When transported by a forklift, the unit must remain mounted on the pallet. The lifting speed should be kept to a minimum. Due to its top heaviness the unit must be secured against tipping over. To prevent any damage or injury, the unit must be placed on a level surface.

Manual Transportation

For manual transport, a wooden pallet can be used to place the unit on. Using ropes or carrying straps, a second or third handling configuration is possible. With this type of handling, care must be taken that the maximum permissible inclination angle of 60 degrees is not exceeded. If transport in an inclined position cannot be avoided, the unit should be left to rest at least one hour after it has been moved into final position before operation.

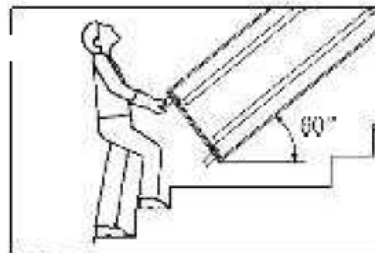

CAUTION: High centre of gravity, place on a level surface!

5.2 Location of Install & Minimum Clearances

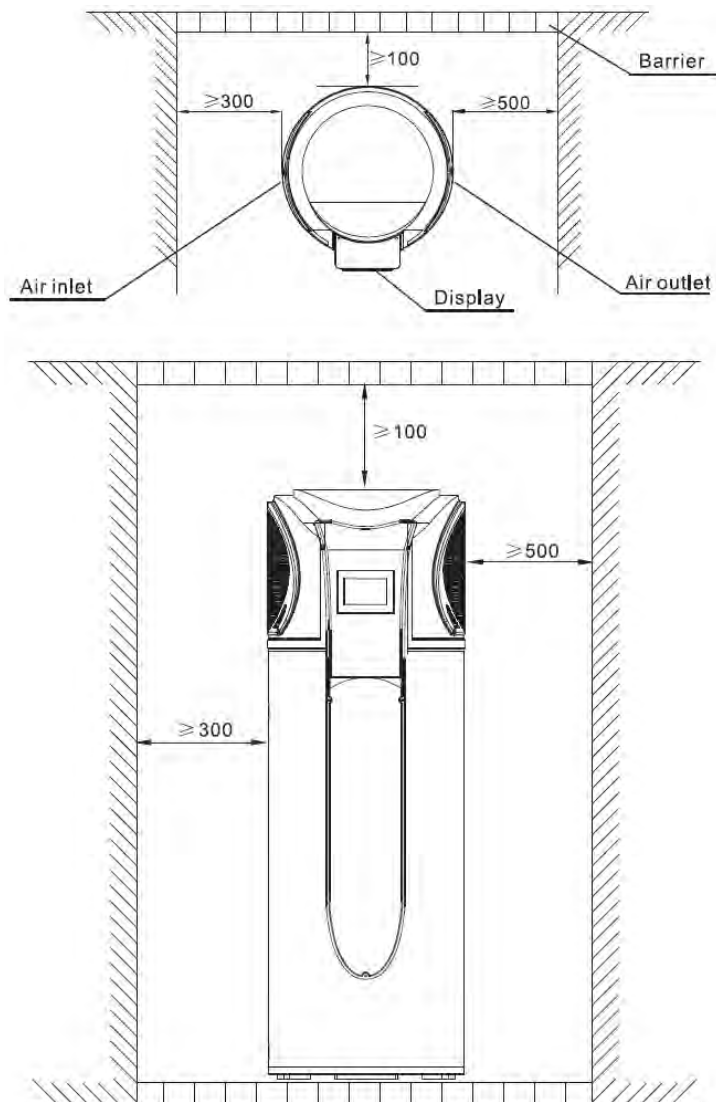

The Evo 270 is designed for external installation; however, if possible, installing the system under the house eaves or in a sheltered environment may help prolong the life of the system.

1. The unit must be installed, operated and maintained in good order and accordance with these instructions.
2. If the water supply exceeds rated pressure a pressure reducing valve is to be fitted.
3. Water may discharge from the drainpipe and this must be left open to the atmosphere.
4. The pressure relief valve must be operated at least every 6 months to ensure correct operation. The drainpipe from this valve should not allow water to collect in pipework.
5. Facilities for draining and filling the unit must be provided to maintenance. Drain points must be at the lowest point of the system.
6. Check before installation that your water pressure is within required limits. Use a filter and pressure relief valve on the inlet as required. A water softening device will also be required in hard water areas.
7. This heat pump must be installed by a licensed contractor. Do not attempt to install yourself if you are not qualified. The Evo 270 must be installed to conform to all relevant Australian Standards and Industry Codes including but not limited to:
 - a. Electrical and Electrical Safety
 - b. Plumbing and Hot Water Storage
 - c. Heat Pump Installation and Operation

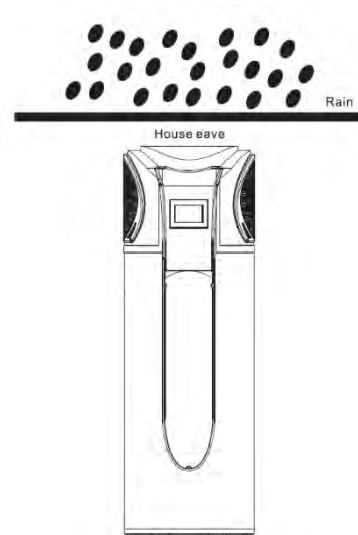

Installation must also comply with any local, state or federal codes at the installation site. Failure to comply can void your warranty, damage your unit and cause possible injury or death. Plumbing must comply with AS/NZS3500.4

Indoor Installation Recommendations

- Heat pumps operate most efficiently with warmer air temperatures, and the outlet air from the unit will always be colder than the inlet air. Therefore, it is advisable to install the unit so it receives the warmest air temperatures possible and that the cold air is not able to recirculate back into the unit.
- The unit may be able to be installed in an unventilated room exceeding 25m³ in volume.
- Venting of cold air is always advisable to prevent the air temperature dropping and lowering the efficiency of the unit.
- Think of the unit as a 3kW air conditioner for the effect it will have on a closed room.

TO COOL THE ROOM USING THE EVO 270

Install the unit so the outlet from the heat pump is blowing INTO the room. The room MUST have some form of air outlet otherwise the performance of the unit will suffer significantly.

TO MAINTAIN THE ROOM AT NORMAL TEMPS USING THE EVO 270

Install the unit so the outlet from the heat pump is blowing OUTSIDE the room. The room MUST have some form of air inlet otherwise the performance of the unit will suffer significantly.

5.3 Cable Connection

The power cable is stored in the back of the unit, it's for power supply of the unit. The spec of the cable is AWG12.

The unit requires an isolating switch as required by local laws. If the power cord is damaged, it must be replaced by a qualified electrician.

5.4 Filling the Tank

Open a hot water tap inside the house. Open the cold-water inlet valve into the Evo 270 to fill the tank. When water begins flowing out of the hot water tap inside the premises, turn off the hot water tap.

5.5 Initial Start-up of the Unit

Pre-Inspection

Check the water supply to the tank and pipe connections for possible leaks.

Check that the following devices are installed and operating correctly:

- Drainpipes
- P&T Valve
- Filter on inlet
- Water softening and pressure reducing devices if required.

Check that all power connections are secure before switching on.

Check that the installation space is adequate.

Trial Operation

Switch on the unit by using the controller.

In the case of any unusual noises, switch the power off and consult your provider.

The parameters have been pre-set to a temperature of 55 degrees. Check that the unit is operating by looking for an increase in water temperature over time.

6. Operation

HEATING CAPACITY

In low ambient conditions the heating output decreases.

WORKING CONDITIONS

In order to use the unit correctly, please run the unit at environment temperature -7 → -43 →

The unit includes sophisticated electronic devices, do not use water from a lake, untreated river water, groundwater and other unsafe water sources!

3 MIN SAFETY PROTECT

If the unit stops and you restart the unit or turn it on manually, the unit will not start to run again for approximately 3 minutes. This is a protection feature to safe guard the compressor.

WATER TEMPERATURE OR PRESSURE PROTECTION

A P&T valve **MUST** be installed in the tank. When the tank pressure reaches 0.85MPa or when the tank temperature reaches 93°C, the P&T valve will open automatically so as to reduce the pressure or temperature decrease.

OVERHEATING PROTECTION

When the water temperature reaches 75°C, the power of the unit will be cut and must be manually reset.

DEFROSTING

In heating mode the unit will defrost automatically, maximising the heating efficiency (lasting 2-10 minutes). The fan motor will stop running whilst the unit is defrosting.

SANITECH HIGH TEMP SANITIZATION

The Evo 270 is fitted with Sanitech. The Sanitech system will heat the tank water to 70°C for one 30 minute period every week at midnight. Please be aware of very high temperature water outlet at this time.

6.1 Main Controller Interface

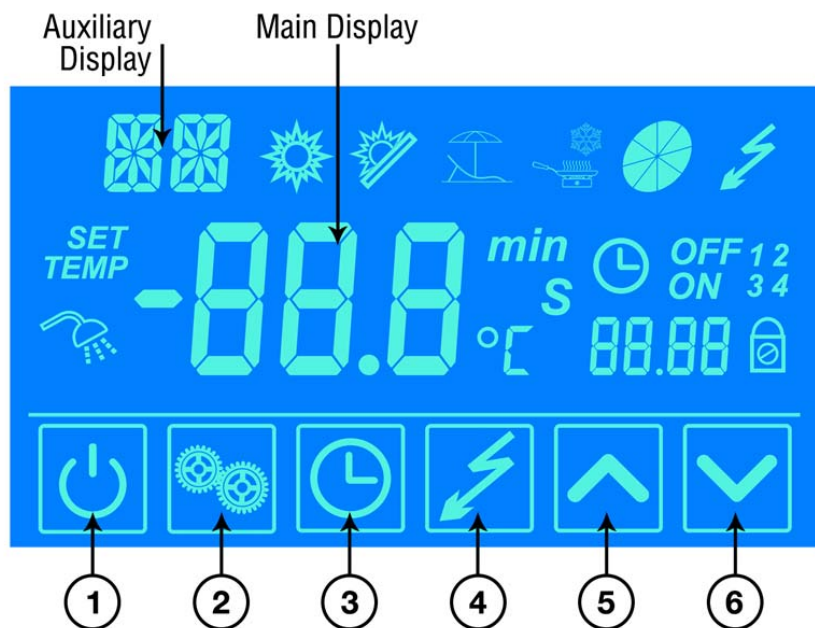



NO.	ICON	NAME	FUNCTION
1		ON/OFF	Turn the unit on or off.
2		MODE	Switch running modes or save setting parameters.
3		CLOCK	Set the clock or the timer.
4		ELECTRIC HEATER	Turn on/off the electric heater or switch fan modes.
5		UP	Move up or increase parameter values.
7		DOWN	Move down or decrease parameter values.

ICON	NAME	MEANING	ICON	NAME	MEANING
	HEATING	The unit is in heating mode	<i>TEMP</i>	TEMPERATURE	Shows the temperature is non-adjustable (measured value).
	HEATING ECO	The unit is in eco. Heating mode		TIMER ON	The unit will be turned on by the timer automatically
	VACATION	The unit is in vacation mode		TIMER OFF	The unit will be turned off by the timer automatically
	COOLING	The unit is in cooling mode	<i>min</i>	MINUTE	The main display area shows the minute
	FAN	Shows the fan is on and the speed of the fan	<i>S</i>	SECOND	The main display area shows the second
	HYDROBOOST HEATER	The Hydroboost electric heater is on		LOCK	The keyboard is locked
	SET TEMPERATURE REACHED	The water temperature has reached target point and will shut off automatically	<i>SET</i>	PARAMETER SETTING	The parameter is adjustable

6.2 Functions of the Controller

6.2.1 Turning the Unit ON & OFF

Press  and hold for 0.5 seconds in the standby screen of the controller to turn the unit on. The main display will now show the water outlet temperature.

Press  and hold for 0.5 seconds in the running screen of the controller to turn the unit off. The main display will now show "OFF".

Note: The ON/OFF button can only be used to turn the unit on/off in standby or on the running screen of the controller.

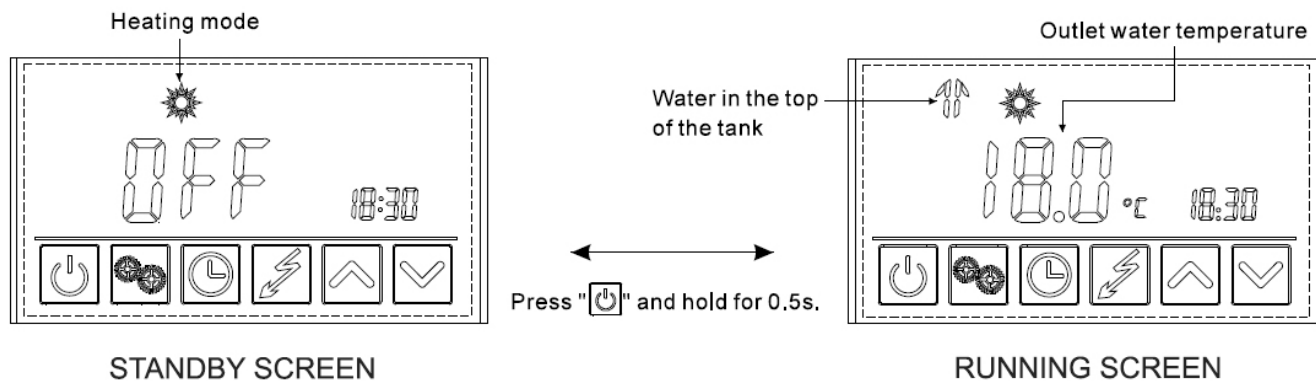

6.2.2 Mode Selection

From the running screen, press  to select one of the modes: Heating, Eco Heating, Intelligent or Vacation

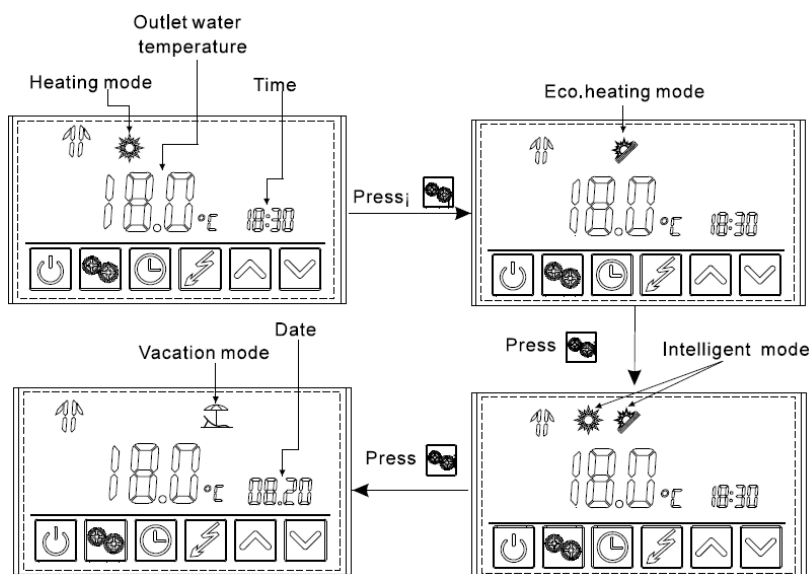

Eco Mode

This mode does not use the Hydropower element boost and is the most economical option. It is recommended to start with this mode initially unless you encounter cold or warm water, then switch to intelligent mode.

Intelligent Mode

This mode will analyse the ambient temperature at 10am each day and decides the best operating mode from Eco or Heating.

Heating Mode

This mode uses the heat pump and the main heat source. The Hydroboost starts after a 40-minute delay to give high recovery rates. Use this mode if you have very high hot water usage. The Hydroboost start times and temperatures are fully customisable.

You can also manually switch on the Hydroboost element at any time by pressing the Hydroboost button on the controller.

Setting the timer to allow the unit to run for longer periods will also help ensure you never run out of hot water.

6.2.3 Target Temperature Checking & Setting

In the standby or running interface, press or once to check the target temperature of the outlet water. Press or again to change the target temperature. After making changes to the desired temperature, press to confirm or to cancel, then return to the previous screen. If the keypad is left idle for 5 seconds, the controller will exit the menu automatically and apply any changes that were made.

Example: Changing the target temperature from 50°C to 55.5°C when the actual outlet water temperature is 18°C.

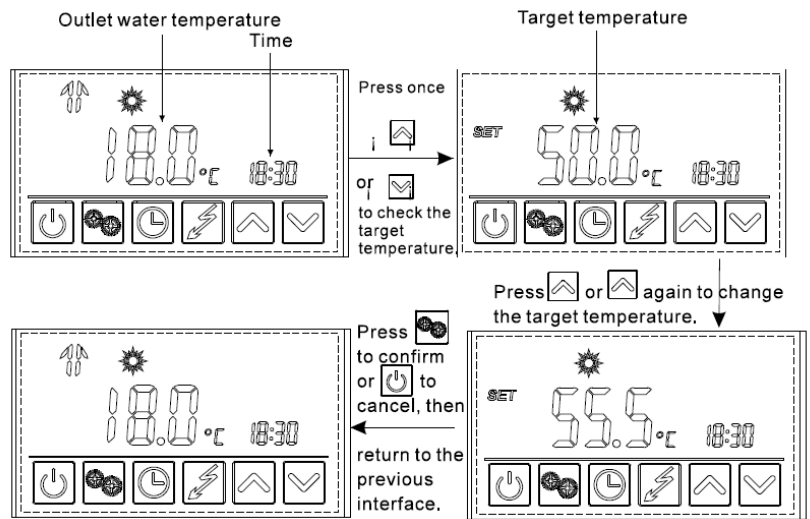

6.2.4 Setting the Date & Time

In the standby or running interface, press once, the time setting will begin flashing. Press the again to make the hour setting begin flashing which indicates it is selected. Press the up or down arrows to adjust the hour time as desired and then press to confirm the setting. Once confirming the previous setting, the flashing selection will then move to the next setting (minutes, then date: mm/dd) where you will need to adjust and confirm your changes. If the keypad is left idle for 10 seconds, the controller will exit the menu automatically and apply any changes that were made. Set the date in the same way when in Vacation mode.

Example: Changing the time & date from 18:30 on August 4th to 17:40 on September 8th.

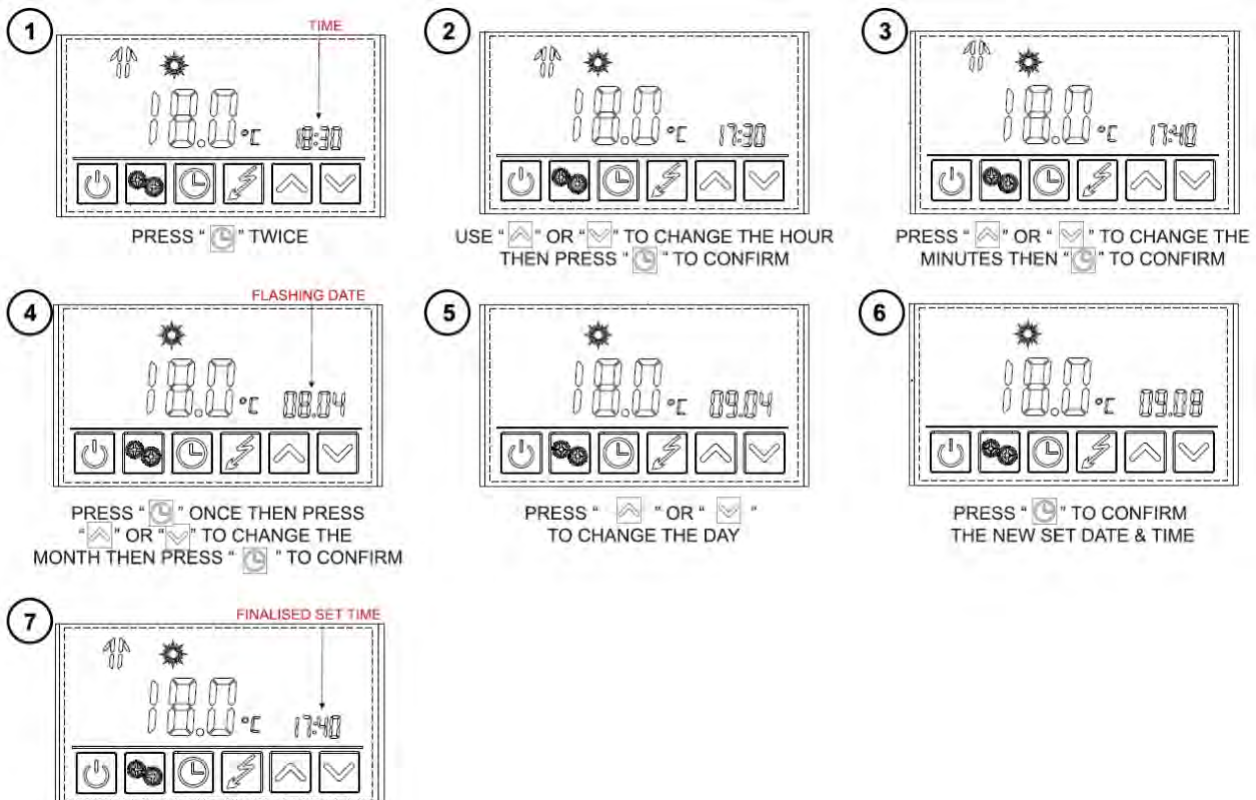

6.2.5 Using the Timer

In heating mode, two running periods can be set.

- Press and hold for 2 seconds to enter the timer setting menu.

Running Period 1: The symbol “ON 1” on the right side of the screen and the time setting will be flashing. Set the time and confirm. The ‘OFF 1’ and the time setting will flash allowing you to adjust it. Set the time as you would in previous steps.

Running Period 2: After Running Period 1 is set, the controller will enter the Running Period 2 settings menu. Set the start-up and shut down times as in the previous steps.

- Press to cancel any modifications during the setting changes.
- Press and hold for 2 seconds twice to set the “OFF 1” time directly, or press / when the unit is already running.
- Press to cancel the setting when the hour parameter is flashing OR to confirm any changes and move to the next value.

EXAMPLE: Running period 1: 8:00 – 10:00 | Running period 2: 16:30 – 20:00

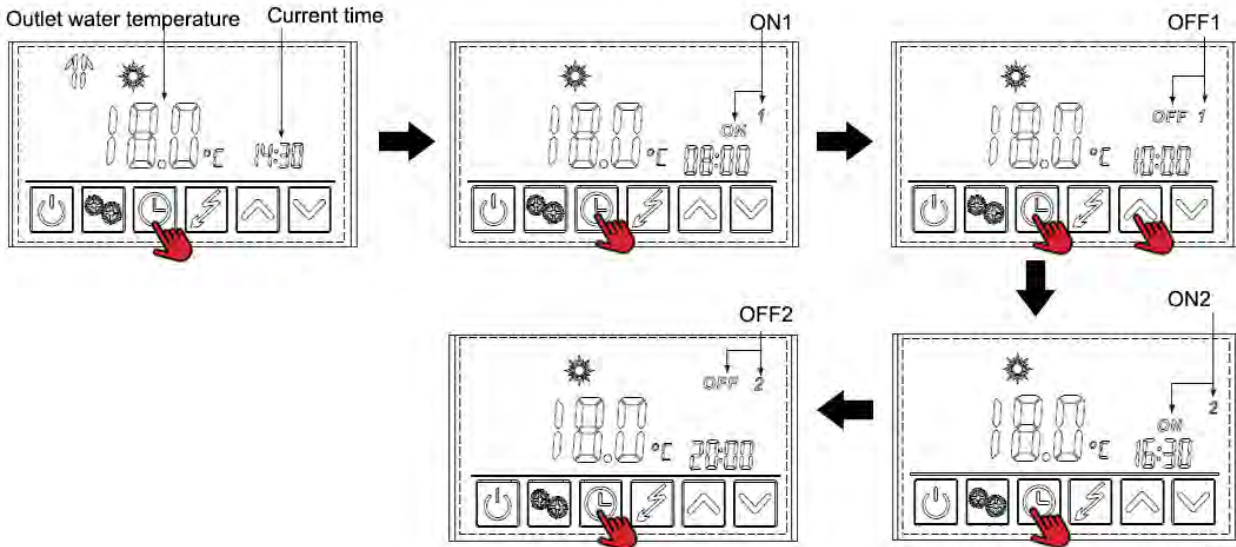

TO CANCEL A TIMER: Example – Cancel Timer ON1

When the hour parameter is flashing, press the ON/OFF button to cancel, then CLOCK to save.

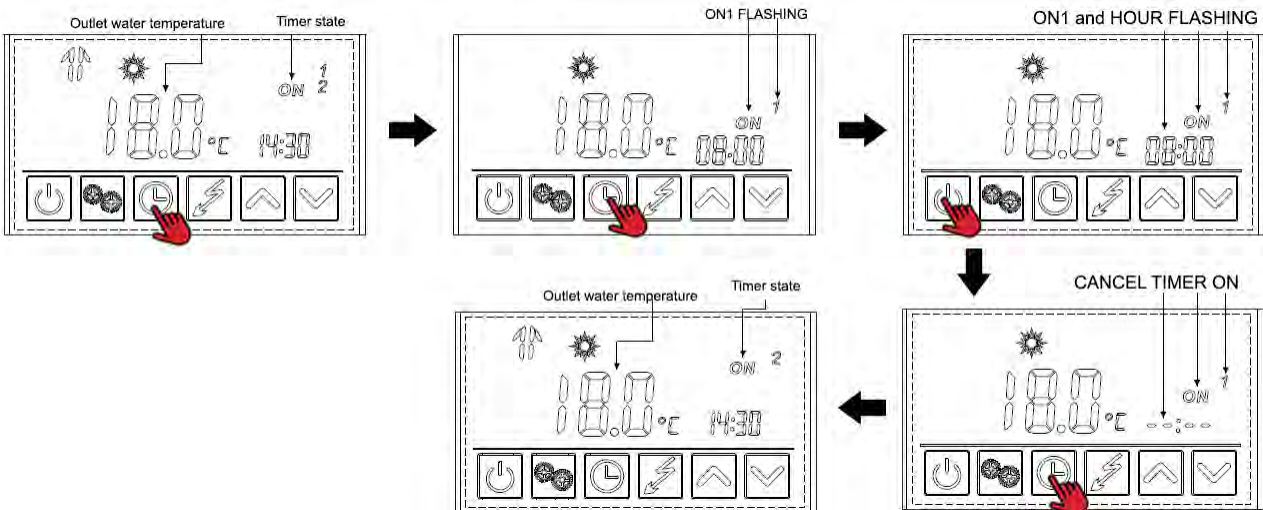

6.2.6 Vacation Mode

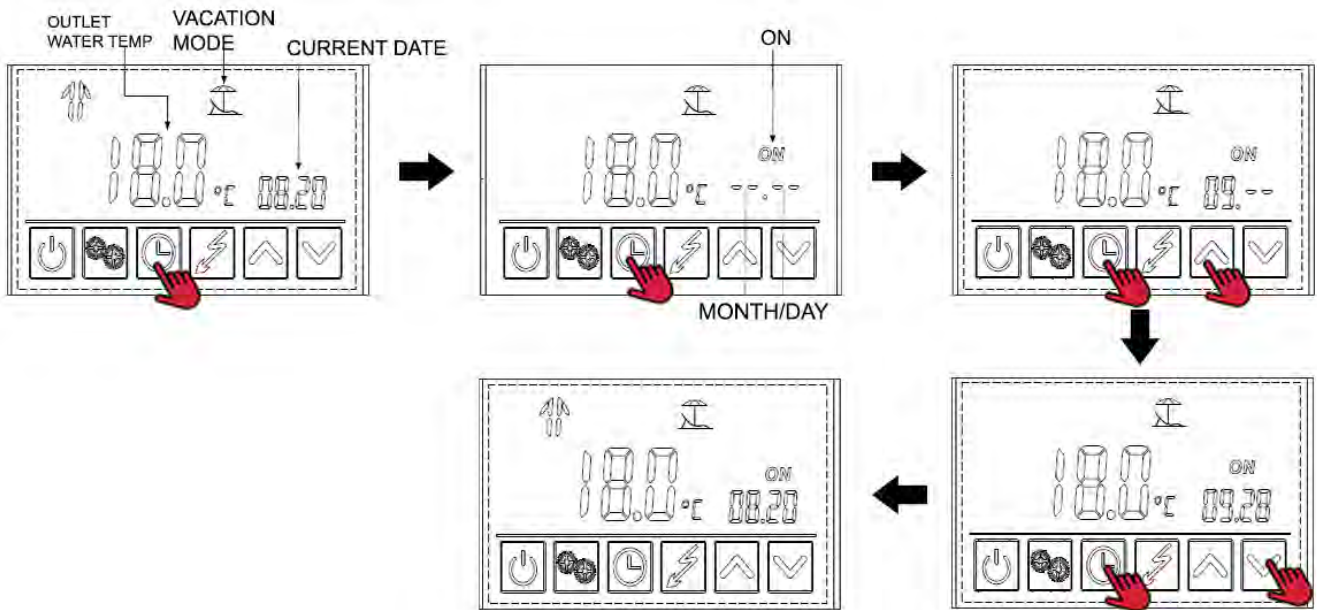

After selecting Vacation mode, press  and hold for 2 seconds to enter into the timer setting menu. The symbol "ON" and the date parameters will be flashing. Set the date the same way as in 6.2.5 Using the Timer.

Example: Set the start-up date on September the 28th. (Turn off the unit before setting the vacation mode)





6.2.7 Hydropower Setting

The Hydroboost heater can be turned on when the unit is heating or on standby.

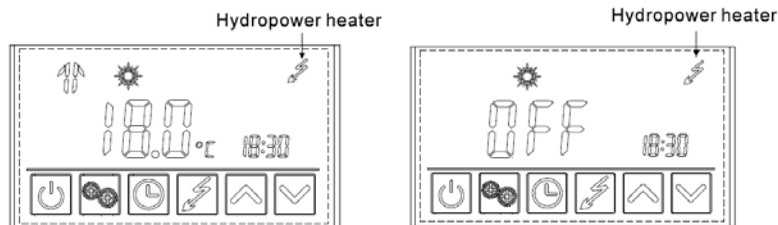



Press  once to turn on the Hydroboost heater and press  again to shut it off.

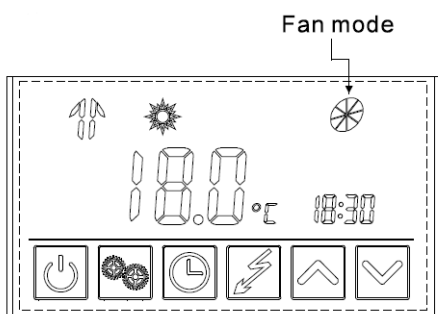

6.2.8 Using Fan Mode



Press  and hold for 2 seconds for the first time to change the fan mode to low speed running. The fan will run at low speed when the unit's target temperature is reached. Press  and hold for 2 seconds again to change the fan mode to high speed running, where it will run at high speed when the target temperature is reached. Press  and hold for 2 seconds for a third time to change the fan mode to shut-down and the fan will stop running when the unit's target temperature is reached.



 (Running)	The fan is running at high speed
 (Running)	The fan is running at low speed
NO FAN ICON	The fan has shut off
 (Static)	The fan will run at high speed when target setting temperature is reached
 (Static)	The fan will run at low speed when target setting temperature is reached

6.2.8 Adjusting the Hydro Power Booster

If there is not enough hot water delivery due to high water usage or continued low ambient temperatures, the Hydro Power Boost system can be adjusted to ensure a steady supply of hot water.

Press  and hold for 10 seconds a single time to access the parameter menus. When the screen displays '000' press the up/down arrow keys until the number '066' is displayed, then press the  key.

Use the up/down arrow keys to navigate to the correct parameter value as shown in the below table, then press the  key to open that parameter value.

Change the value using the up/down arrow keys and press the X key to save changes. Press  to exit the menu.

***Changing values in other parameters other than show below could affect the performance and warranty of your Evo270 and is not advised unless instructed by an EvoHeat technician.**

Description	Parameter	Default	Range
Enable adjusting set point of Hydro Power	r04	0	0-No/1-Yes
Hydro Power set point	r05	55 degrees	30-90 degrees
Hydro Power startup delay	r06	200 minutes	0-450 minutes
Hydro Power to replace heat pump	r07	0	0-No/1-Yes
Ambient temperature when Hydro Power replaces heat pump	r08	-5 degrees	-20 to 10 degrees
Ambient temperature for Hydro Power to start without delay	r09	10 degrees	0-30 degrees
Ambient temperature for Hydro Power to start with delay	r10	25 degrees	10-40 degrees

6.2.9 Adjusting the Sanitech System



Follow the same steps as with the Hydro Power Booster above, but adjust the parameters starting with a 'g'.

To disable the Sanitech feature, simply adjust the Sanitech target temperature (g01) to a figure below the normal water storage temperature (generally 50 degrees or lower).

***Changing these settings may lower or disable the Evo270's ability to ensure your water is free from bacteria.**

Description	Parameter	Default	Range
Sanitech Target Temperature	g01	70 degrees	30-70 degrees
Sanitech Temperature Hold Time	g02	30 minutes	0-90 minutes
Sanitech Start Time (24hour clock)	g03	0 hours	0-23 hours
Sanitech Operation Cycle	g04	7 days	7-99 days

6.2.10 Locking the Keyboard

Press  and hold for 5 seconds once to lock the keyboard. Press  and hold for 5 seconds again to unlock the keyboard.

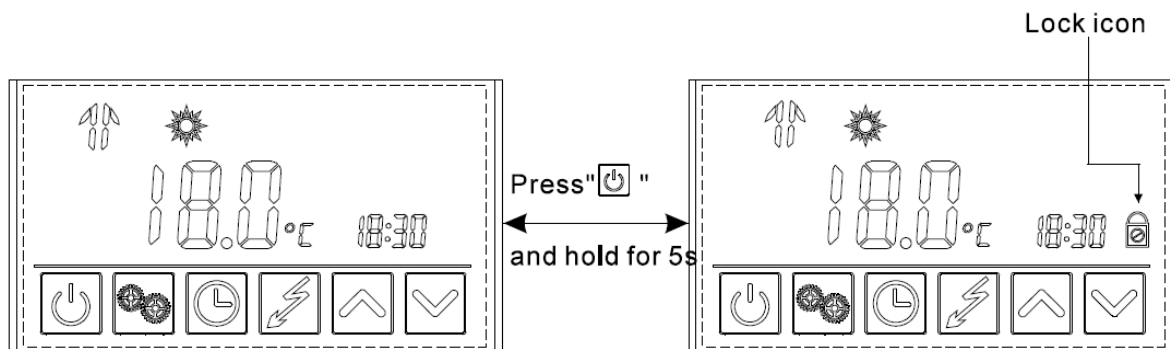

7. Troubleshooting



EvoHeat have developed a YouTube Channel where you will find useful videos regarding using the controller and potential errors. Be sure to have a look to see if the answer to your question is there:
<https://www.youtube.com/channel/UCfYiOxHuybBuC1NZcqUnrcA>

Malfunction	Display	Cause	Solution
Bottom water temp. failure	P01	The water bottom temp. sensor is open or short circuit.	Check or change the water bottom temp. sensor
Top tank water temp. failure	P02	The water top tank temp. sensor is open or short circuit	Check or change the water top tank temp. sensor
Ambient temp. failure	P04	The ambient temp. sensor is open or short circuit	Check or change the ambient temp. sensor
Coil temp. failure	P05	The pipe temp. sensor is open or short circuit	Check or change the pipe temp. sensor
Refrigerant absorb temp. failure	P07	The evaporator temp. sensor is open or short circuit	Check or change the evaporator temp. sensor
Anti-freeze temp. failure	P09	The anti-freeze temp. sensor is open or short circuit	Check or change the anti-freeze temp. sensor
High pressure protection	E01	The exhaust pressure is high, high pressure switch action	Check high pressure switch and cooling return circuit
Low pressure protection	E02	The suction pressure is low, low pressure switch action	Check low pressure switch and cooling return circuit
Water flow failure	E03	No water or litter water in water system	Water, check for flow volume pump failure
Electric-heater overheat protection	E04	Water flow volume not enough, water system pressure difference is small	Water, check if the flow volume system is jammed
Anti-freeze protection	E07	Water flow volume not enough, water system pressure difference is small	Water, check if the flow volume system is jammed
Anti-freeze protect level 1	E19	Ambient temperature is too low	
Anti-freeze protect level 2	E29	Ambient temperature is too low	

8. Appendix

8.1 Parameter List

Definition	Default	Note
Target Temperature	55	Adjustable

8.2 PCB Description

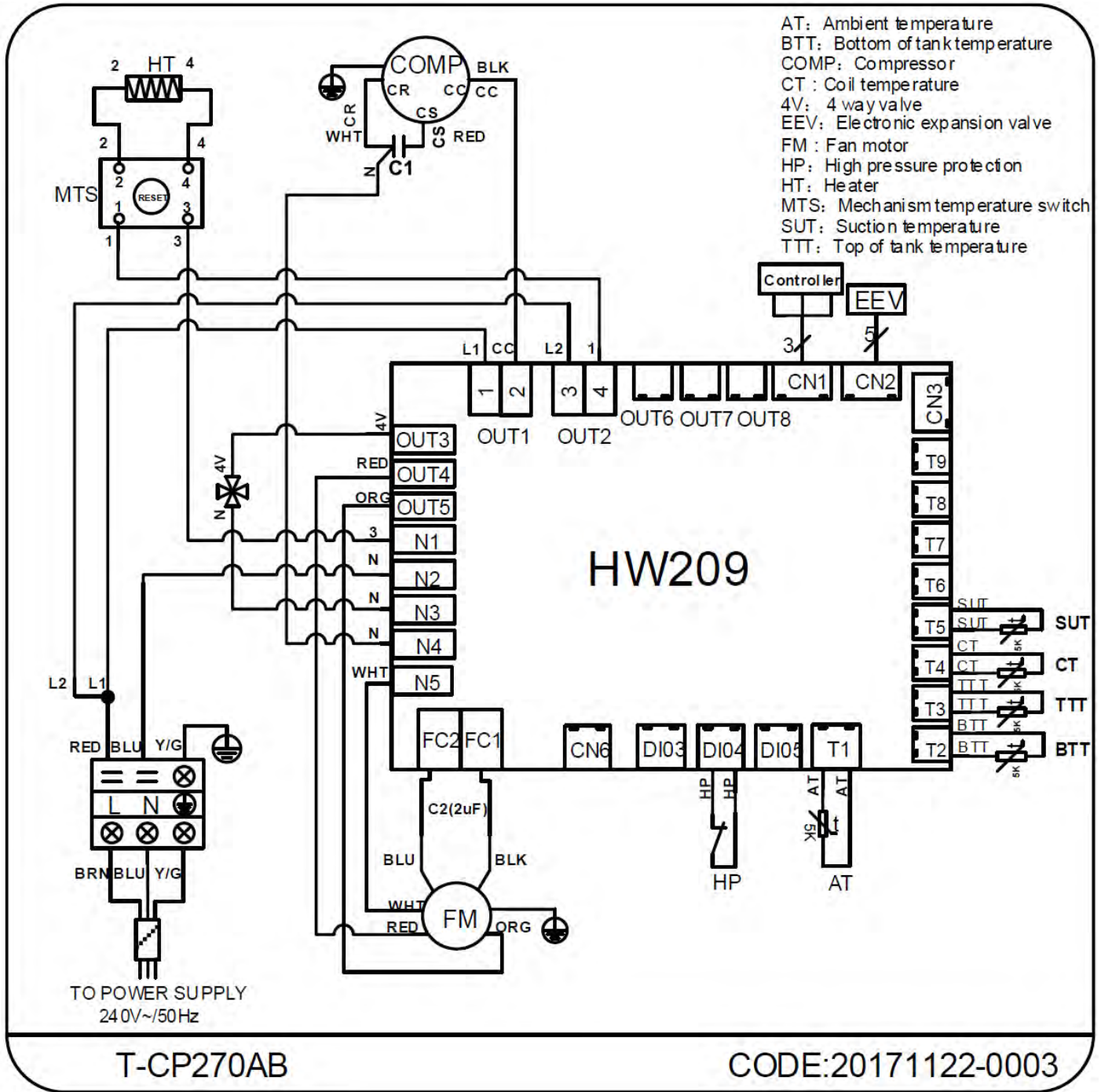

NO.	Symbol	The Definition of the Ports
1	OUT1	Output for compressor (220~240VAC)
2	OUT2	Output for electric heater (220~240VAC)
3	OUT3	Output for 4-way valve (220~240VAC)
4	OUT4	Output for the high speed of fan motor (220~240VAC)
5	OUT5	Output for the low speed of fan motor (220~240VAC)
6	OUT6	Not used
7	OUT7	Not used
8	OUT8	Not used
9	CN1	Communication port for the display
10	CN2	Electronic expansion valve
11	CN3	Not used
12	CN6	Not used
13	DI03	Not used
14	DI04	High pressure protection
15	DI05	Not used
16	T1	Ambient temperature detector
17	T2	Bottom temperature detector
18	T3	Top temperature detector
19	T4	Coil temperature detector
20	T5	Suction temperature detector
21	T6	Not used
22	T7	Not used
23	T8	Not used
24	T9	Not used
25	FC1/FC2	Fan capacitor
26	N1~N5	Neutral

8.3 Detailed Parts Overview

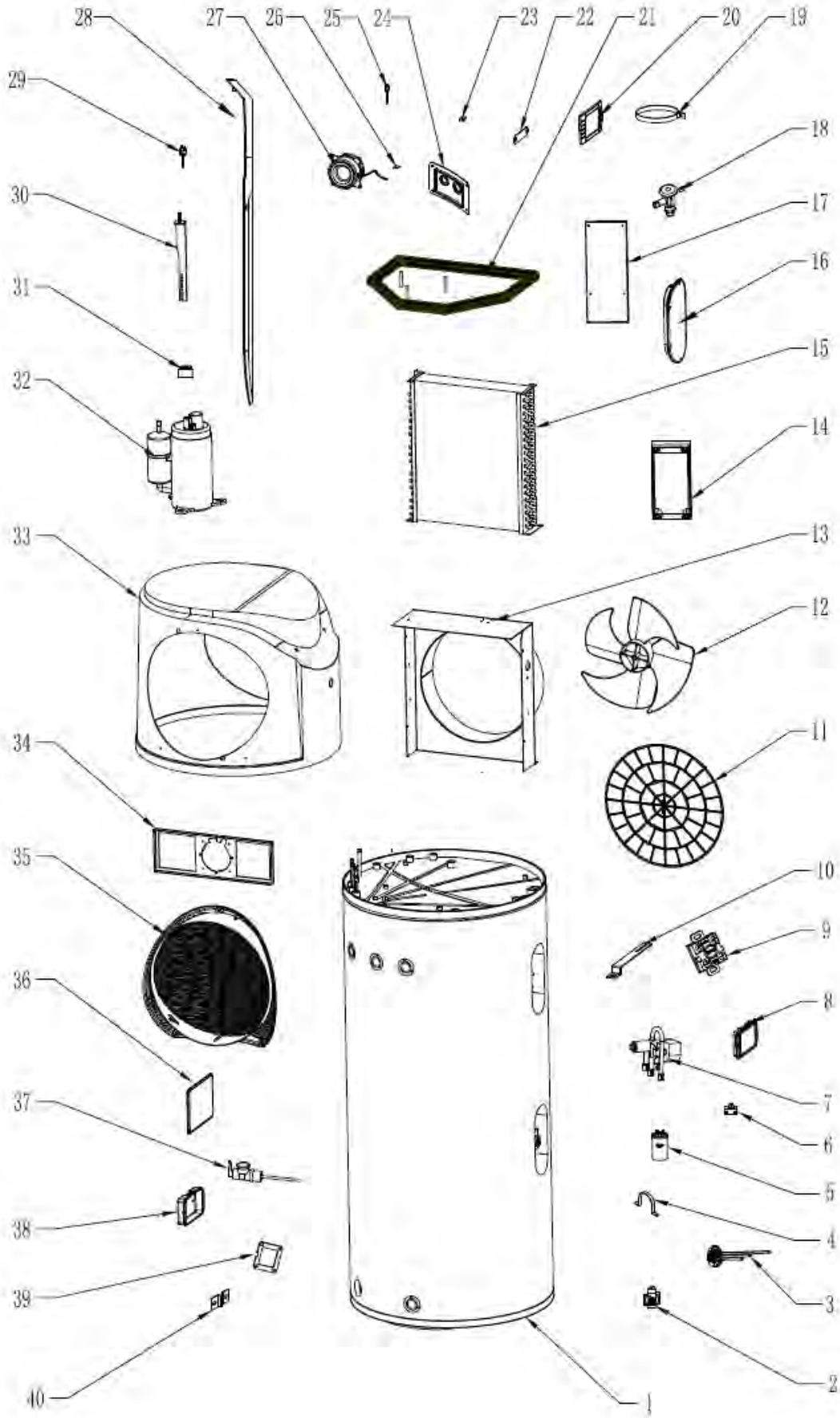

Number	Material Code	Material Name	Specification	Remark
1	68016-040052	Water tank 270LD	270LD, 640, double pipes	
2	20000-370006	Transformer for the power supply	41X26.5F red VH-3	
3	20000-000032	Electric heater	1.5KW	
4	2000-2118	Retainer for capacitor (180 J)	Galvanized sheet 0.8/CY 30-35uF	
5	2000-3504	Compressor capacitor	CBB65-35F/450V	Diameter 55*85
6	2000-3506	Fan capacitor	CBB61-2F/450V	
7	2001-1418	4-way valve	SHF-7H-34U/C02C00S/STF-0218G R410A	
8	2001-2265	Transparent cover for the controller	For DZ controller	
9	20000-360040	Mechanical temperature controller	66TM 85 degree	
10	38004-210013	Pull rod	295;45;30	
11	38016-220006	Strainer	404 PP injection molding	
12	2000-2706	Axial flow fan	365;113	
13	38016-210019	Air outlet vent component	Assembled component	
14	2001-2262	Plastic waterproof box	11-58240;120;90mm	
15	38016-120029	Evaporator	7.94 copper pipe	Q design
16	20000-220093	Cover	ABS white Material	
17	38016-21 0030	Support for the electrical box	Galvanized sheet 1.0	L design
18	20000-140216	Thermostatic expansion valve	TDEN1 0.9TR 3.8kW	
19	38017-210024	Retainer	Galvanized sheet 2.0, black	
20	2001-2264	Decorative cover for the controller	For DZ controller	
21	38016-210018	Chassis design	Galvanized sheet 1.2	
22	38017-210010	Fixed plate for the electrical box	Galvanized sheet 1.2	
23	20000-880032	Magnet	Magnet in opposition	
24	20000-220130	Cover plate for the wires	ABS grey colour code RAL7016	
25	2000-1404	Needle point valve	High or low pressure	
26	20000-880050	Retainer for the magnet	15;24;1.0	
27	20000-330087	Axial flow motor	GAL6P28A-KWDB	Galanz
28	38017-220047	M design decorative plate	ABS blister plastic component	
29	2000-3607	Press switch	2.1 MPa/1.7MPa	
30	38016-21 0024	Pull rod for the compressor	Galvanized sheet 3.0	
31	2000-2654	Rubber feet	25;20	
32	20000-110108	Compressor(H74)	WHP03970BSV	
33	38016-220008	Top cover	ABS 640 grey matte surface	
34	38016-21 0020	Support for motor	Galvanized sheet 1.2	
35	38016-220005	Air outlet vent net	ABS injection moulding	
36	38017-220023	Cover plate for the wire controller	ABS injection mould parts	
37	20000-130143	P&T valve	6' female thread 6' male thread brass	
38	20000-220091	Back cover for the controller	For mounted to the unit	
39	38017-210009	Fixed plate	Galvanized sheet 1.0	
40	38017-210055	Retainer for the temperature sensor	Galvanized sheet 0.8	

8.4 Caution

To reduce the risk of excessive pressures and temperatures in this water heater, install temperature and pressure protective equipment required by local codes. A combination temperature and pressure relief valve must be certified by a nationally recognized testing laboratory that maintains periodic inspection of production of listed equipment or materials, as meeting the requirements for Relief Valves and Automatic Gas Shutoff Devices for Hot Water Supply Systems, AS1357.1. This valve must be marked with a maximum set pressure not to exceed the marked maximum working pressure of the water heater. Install the valve into an opening provided and marked for this purpose in the water heater. Install the P&T Valve or provide tubing so that any discharge from the valve exits only within 6 Inches above, or at any distance below, the structural floor, and does not contact any live electrical part. The discharge opening must not be blocked or reduced in size under any circumstances.

Hydrogen gas is produced in a hot water system served by this heater that has not been used for a long period of time (2 weeks or more). Hydrogen gas is extremely flammable. To reduce the risk of injury under these conditions, it is recommended that the hot water faucet be opened for several minutes at the kitchen sink before using any electrical appliance connected to the hot water system. When hydrogen is present, there will probably be an unusual sound such as air escaping through the pipe as the water begins to flow.

There should be no smoking or open flame near the faucet at the time it is open.

8.5 Earthing Methodology

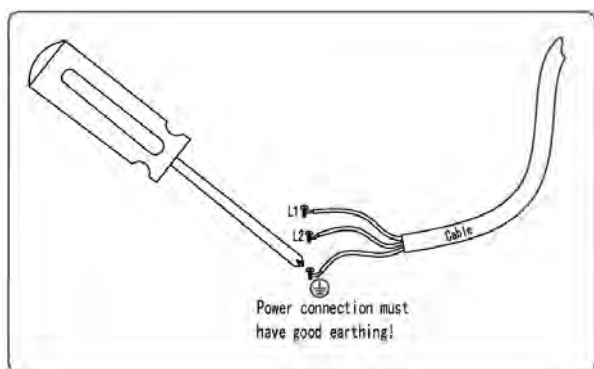

8.6 Use of the P&T Valve

The P&T valve is used to prevent the temperature or pressure becoming too high inside the tank. When the temperature or pressure reaches the set value, the valve will open automatically so as to force the pressure or temperature to decrease.

The handle of the safety valve should be tested once every six months so as to remove the calcium carbonate deposits and guarantee there is no blockage in the device. Take care to avoid burns for the temperature of the discharging water is very high.

Vent pipes should be thermally insulated to prevent safety risks caused by freezing pipes in winter.



8.7 Using the Overheating Protector

return the unit to its normal operational status it will have to be re set manually. Please contact EvoHeat for a service if this occurs.

OPERATION DETAILS

To access the overheat protector the front dark grey controller panel must be removed.

Remove the 3 screws on the front panel and push the front cover upwards.

Then remove the screws covering the overheat protector panel as below:

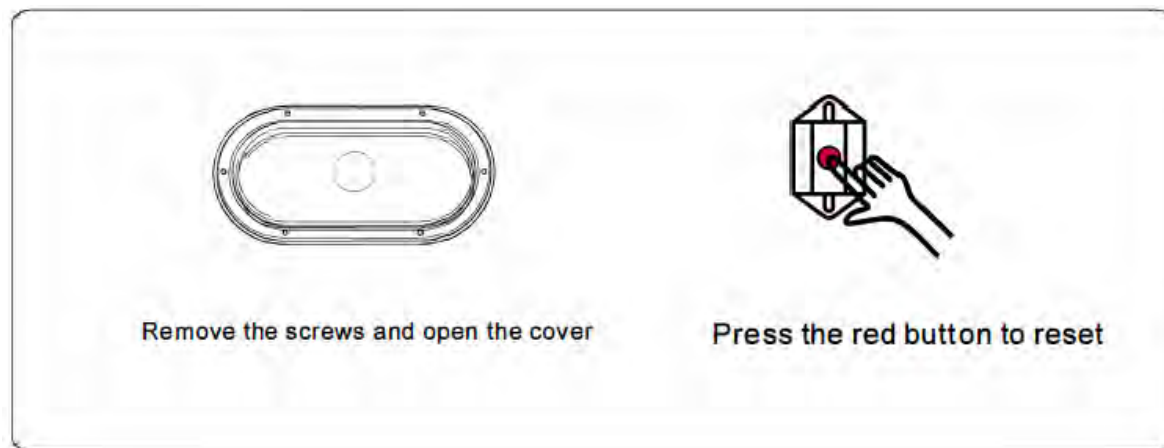

8.8 Draining the Water Tank

1. Close the cold-water inlet valve into the Evo 270.
2. Open a hot water tap inside the premises.
3. Undo the drain plug on the base of the unit to drain the water from the system.

**CAUTION: THE WATER FROM THE HOT WATER TAP AND THE DRAIN PLUG WILL BE HOT.
BE CAREFUL OF BURNS AND SCALDS. WEAR PROTECTIVE CLOTHING**

9. Maintenance

Your Evo 270 will operate most efficiently if regularly inspected as part of your home maintenance schedule.

MINOR ANNUAL MAINTENANCE

It is recommended that the minor maintenance be performed every 12 months by the dwelling occupant.

The minor maintenance includes:

- Operate the easing lever on the temperature pressure relief valve. It is very important you raise and lower the lever gently. Exercise care to avoid any splashing of water, as water discharged from the drain line will be hot. Stand clear of the drain lines point of discharge when operating the valve's lever.
- Operate the easing level on the expansion control valve (if fitted). It is very important you raise and lower the lever gently.
- Conduct a visual inspection of all plumbing and electrical connections.
- Check the condensate drain line to ensure it is not blocked.
- Check that air vents are not blocked or obstructed, and if necessary clean with a damp cloth or air blower.
- Conduct a general external clean of the unit with a damp cloth.

MAJOR FIVE YEAR SERVICE

It is recommended a major five (5) year service be conducted on the Evo 270.

Warning: Servicing of a water heater must only be carried out by qualified EvoHeat personnel. Phone EvoHeat Service on 1300 859 933 for our closest Accredited Service Agent.

Note: The five-year service and routine replacement of any components such as the anode and relief valve(s) are not included in the EvoHeat warranty. Only genuine replacement parts should be used on this water heater.

The major service includes the following actions:

- Replace the temperature limiting valve.
- Replace the temperature pressure relief valve.
- Inspect the anode and if required, replace the anode. If the anode is not replaced, it should be replaced within three years of this service.
- Check the heating cycle of the unit.
- Visually check the unit for any potential problems.
- Inspect the plumbing and electrical all connections.
- Check the condensate on drain line to ensure it is not blocked.

Note: The water heater may need to be drained during this service. After the completion of the service, the water heater will take some time to reheat the water. Depending upon the power supply connect on, hot water may not be available until the next day.

10. Warranty



Please refer to the EvoHeat website for warranty details

- Australia: www.evoheat.com.au
- South East Asia: www.evoheat.com.sg

1. Warranty terms are from date of purchase.
2. This warranty excludes any defect or injury caused by or resulting from misuse, abuse, neglect, accidental damage, improper voltage, vermin infestation, incompetent installation, any fault not attributable to faulty manufacture or parts, any modifications which affect the reliability or performance of the unit.
3. This warranty does not cover the following:
 - a. Natural Disasters (hail, lightening, flood, fire etc.)
 - b. Rust or damage to paintwork caused by a corrosive atmosphere
 - c. When serviced by an unauthorized person without the permission of Evo Industries
 - d. When a unit is installed by an unqualified person
 - e. Where a unit is incorrectly installed
 - f. When failure occurs due to improper or faulty installation
 - g. Failure due to improper maintenance (refer Operating Instructions)
 - h. 'No Fault Found' service calls where the perceived problem is explained within the
 - i. Costs associated with delivery, handling, freighting, or damage to the product in transit.
4. If warranty service is required you should:
 - a. contact Evo Industries Australia on 1300 859 933 or via our Contact page on our web site
 - b. provide a copy of your receipt as proof of purchase
 - c. have completed the online warranty registration or provide a completed warranty card.
5. Onsite technical service is available within the normal operating area of your Evo Industries authorized Service Centre. Service outside this area will incur a traveling fee.
6. Unless otherwise specified to the purchaser, the benefits conferred by this express warranty and additional to all other conditions, warranties, rights and remedies expressed or implied by the Trade Practices Act 1974 and similar consumer protection provisions contained in legislation of the States and Territories and all other obligations and liabilities on the part of the manufacturer or supplier and nothing contained herein shall restrict or modify such rights, remedies, obligations or liabilities.

Warranty Registration

EvoHeat highly recommend customers to complete their warranty details online to ensure efficient warranty claim processing.

To register your warranty, scan our QR Code or head to our website and fill in the Warranty Registration Form: <https://evoheat.com.au/warranty-registration/>

